

MARQUARDT

STANDARD SWITCHES

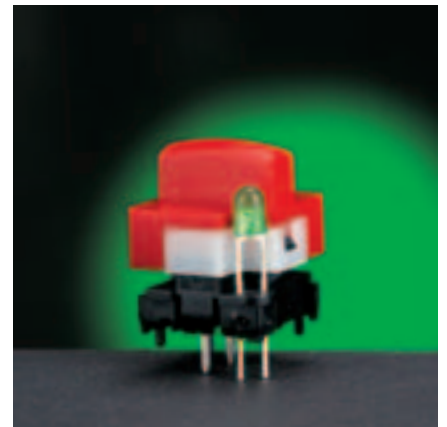

MARQUARDT

QUALITY AS A PROGRAM

APPLIANCE SWITCHES - SNAP ACTION SWITCHES - KEYMODULES



This catalog provides you with information about our wide range of appliance switches, snap action and keymodules. All standard versions are listed with their part numbers. Further information and the part numbers of special versions are available upon request. We would be glad to send you switch samples and drawings with complete tolerance specifications. The high quality and long-life switches from Marquardt are used in many different applications. We are constantly working on new developments and customized versions. Please ask for details.

Our entire program is distinguished by one common feature: The consistently high quality level which has made us the favorite supplier to leading manufacturers worldwide. We are certified according to ISO TS 16949:2002, the current QM-standard of the automotive industry. Quality is the most important part of our program.



1



TECHNICAL INFORMATION

Pages **1.1 - 1.5**

2



APPLIANCE SWITCHES

Pages **2.1 - 2.48**

3



SNAP ACTION SWITCHES

Pages **3.1 - 3.33**

4

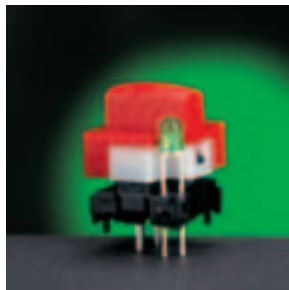

KEYMODULES

Pages **4.1 - 4.9**

5

INDEX OF PART NUMBERS









Pages **5.1 - 5.3**

TECHNICAL INFORMATION

APPROVALS

Almost all of Marquardt's switches are tested according to EN 61058-1 resp. IEC 1058-1 and carry either the standard European test mark ENEC or the national test mark. Licences for the USA and Canada are granted according to UL 1054 and C 22.2 - 55 respectively. Please see the catalog for the appropriate approval marks. The corresponding certificates are available on request.

APPROVAL MARKS

 Germany °	 Switzerland °	 Italy °
 Denmark °	 Netherlands °	 USA
 Norway °	 Austria °	 Canada
 Sweden °	 France °	 Canada and USA
 ENEC		

° = is replaced by ENEC

ELECTRICAL RATING

The maximum permissible electrical load is specified for the respective switch series. Most Marquardt switches are suitable for both resistive and motor loads. The rated current for the motor load is specified in brackets, e.g. 16 (4) A 250 V~. Switches also approved by UL and CSA approval authorities are marked in our catalog in blue, with the corresponding rating.

Information about ratings for direct current (DC) will be provided on request.

LIFE ENDURANCE

The mechanical life endurance is the number of possible switching cycles without electrical loading of the contacts. The electrical life endurance is determined with the permissible electrical loading of the contacts. The lower the electrical load the closer the electrical life endurance gets to the mechanical endurance.

GOLD-PLATED CONTACTS

We recommend using switches with gold-plated contacts for applications in which the electrical rating is ≤ 300 mW or ≤ 12 V. We also recommend gold-plated contacts for applications that are rarely actuated or in sulphurous atmospheres. We will be glad to advise you on special applications.

FREQUENCY OF OPERATION

Switches that are expected to be actuated more than 2,000 times a year must be approved for an electrical life endurance of $\geq 50,000$ cycles. Most of our appliance and snap action switches meet this requirement and are marked with the symbol 5E4 (next to the rating indications). Switches without this symbol are approved for an electrical life endurance of $\geq 10,000$ cycles.

Please be aware of appliance requirements.

RESISTANCE TO TRACKING

The resistance to tracking (PTI/CTI values) indicates the maximum voltage that the tracking resistance can withstand. The values specified in the catalog correspond to the classification according to EN 61058-1 respectively IEC 1058-1.

INRUSH CURRENTS OF CAPACITIVE LOADS

Brief capacitive peak currents occur when switching on mainly in appliances with power supply units (e.g. computers, printers, fax machines). These currents have a typical duration of < 10 ms. The test conditions, with a special test circuit, are defined in EN 61058-1 respectively IEC 1058-1.

For the majority of our appliance switches, values above the possible capacitive inrush currents according to the above mentioned standards are available. The designation includes the permanent current and the maximum inrush current as well as the voltage, e.g. 5/100 A 250 V~.

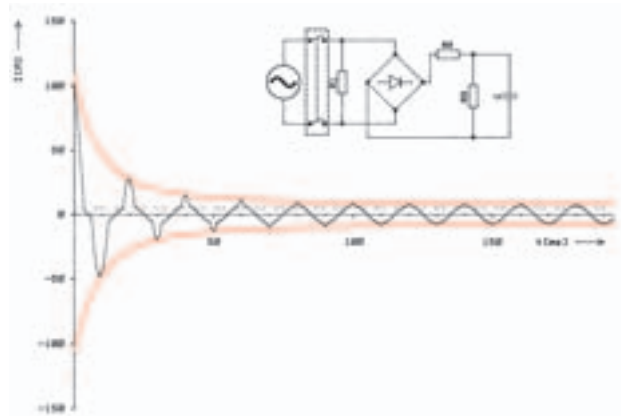

AMBIENT TEMPERATURE

The marking e.g. T 85 means that the switch is approved by the European approval authorities (according to EN 61058-1 resp. IEC 1058-1) for the max. ambient temperature of 85 °C. The marking T 85/55 means, that the terminal side of the switch is suitable for an ambient temperature of 85 °C and the actuating element (e.g. the rocker) for a room temperature of 55 °C. When using the switch outside the admissible ambient temperature, or in very moist or corrosive atmosphere, the function can be impaired considerably.

The ambient temperature of  approved switches is determined by the RTI (Relative Temperature Index) of the materials used. The permissible ambient temperature of polyamides is generally 65°C. Switches for higher ambient temperatures are available on request.

IP-PROTECTION TYPE

The IP protection classes in accordance with DIN EN 61058-1 specified in our documents refer - unless stated otherwise - to the actuating side of the switch. The sealing between the switch and the customer's device and the testing of the tightness at this position is the customer's responsibility.

CONTACT GAP

Most of our appliance switches and some snap action switches have a contact gap of ≥ 3 mm and are suited for disconnecting the appliance from the power supply.

Switches with a contact gap of < 3 mm are not recommended for use as primary power disconnect. These switches are marked with the sign . In these cases the approval authorities usually require a plug or a separation device in the installation. In case of any doubt, we recommend to contact your approval authority.

TECHNICAL INFORMATION

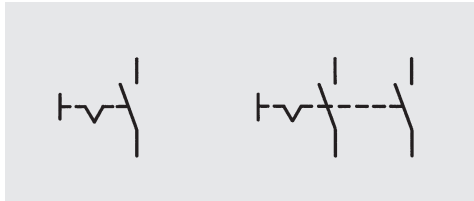

Single pole and double pole-single throw
(SP-ST / DP-ST)



Single pole and double pole-single throw
(SP-ST / DP-ST) with indicator lamp

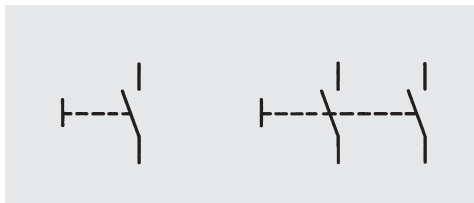

Single pole and double pole-normally open
(SP-NO / DP-NO)

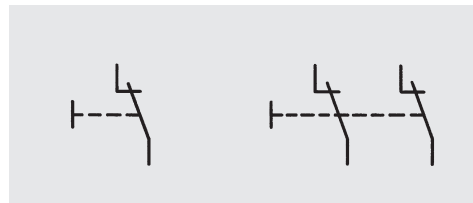

Single pole and double pole-normally closed
(SP-NC / DP-NC)

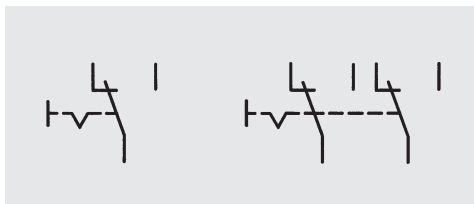

Single pole and double pole-double throw
(SP-DT / DP-DT)

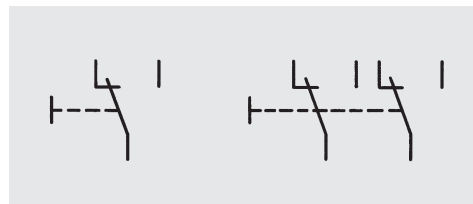

Single pole and double pole- double throw
(SP-DT / DP-DT) momentary function

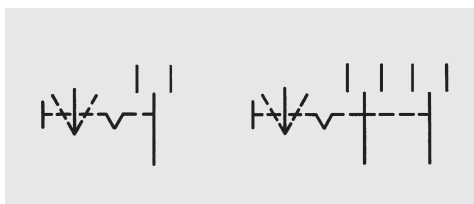

Single pole and double pole-double throw
(SP-DT / DP-DT) with centre-OFF

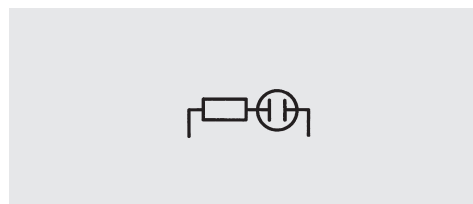

Pilot light

EMC (SPURIOUS RADIATION / SPURIOUS EMISSION)

The EN 61058-1 does not contain appropriate regulations for switches. Requirements for interference suppression of the devices can be found in the equipment regulations of EMC regulations.

REGULATIONS FOR PROTECTION OF MACHINES

We recommend the use of switches with approval marks EN 61058-1 resp. IEC 1058-1, if you have to meet the regulations of the standard institutions for protection of machines. Switches without approval marks have to be tested by your approval authority under special conditions with the appliance.

CE-MARKING

Our appliance switches and snap action switches meet the requirements of the low voltage directive 73/23/EEC with supplement 93/68/EEC as electrical devices. A CE mark on the components is not prescribed, the mark is made on the smallest packaging unit. The device must meet the requirements of the EMC directive.

TERMINALS

 quick-connect terminal	 bent PCB terminal
 solder terminal	 angled PCB terminal
 short solder terminal	 bush-terminal
 PCB terminal	

PART NUMBERS

The 8-digit part numbers for our switches are indicated below the corresponding pictures, after the terminal symbols. Accessory parts have a 9-digit part number.

SWITCHES ON STOCK / MINIMUM ORDER QUANTITIES

Many of our standard switches are usually available immediately from stock to 4 weeks in quantities of at least one packaging unit (PU). These versions are marked by *. Please ask for delivery times for the unmarked versions.

You will find a list of all switches defined to be on stock and their packaging units on pages 5.2 and 5.3.

CHANGES / CATALOG DATA

We reserve the right to alter switches in accordance with technical improvements. The catalog data (e.g. dimensions, photos, drawings) are not binding. Samples and drawings including tolerances are available on request.

APPLICATION INDICATIONS / LIABILITY

Since all data in this catalog refer exclusively to the switches supplied by us, the customers themselves are responsible for the examination whether our switches are suitable for the individual case planned by them. Please contact us for further information.

Our liability is exclusively based on our terms of payment and delivery, which we send you on request.

1



TECHNICAL INFORMATION

Pages **1.1 - 1.5**

2



APPLIANCE SWITCHES

Pages **2.1 - 2.48**

3



SNAP ACTION SWITCHES

Pages **3.1 - 3.33**

4

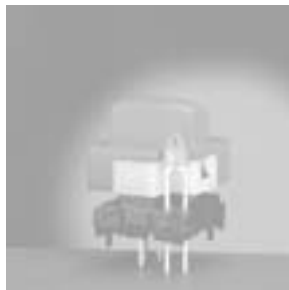

KEYMODULES

Pages **4.1 - 4.9**

5

INDEX OF PART NUMBERS

pages **5.1 - 5.3**

CONTENTS APPLIANCE SWITCHES

For an index of all versions on stock and their packaging units see pages **5.2** and **5.3**.

ROCKER SWITCHES



SERIES 1900

single pole, without indicator lamp
6 (2) A 250 V~

Appliance cut-out: 19.2 x 6.8 mm
23.2 x 6.8 mm
30.0 x 6.8 mm

Pages
2.4 - 2.5

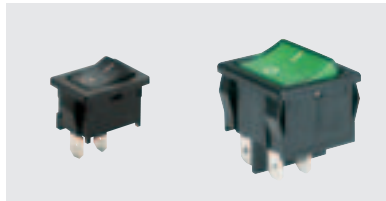

SERIES 1800

single pole and double pole
with and without indicator lamp
12 (4) A 250 V~

Appliance cut-out: 19.2 x 12.9 mm
19.2 x 21.9 mm

Pages
2.6 - 2.11

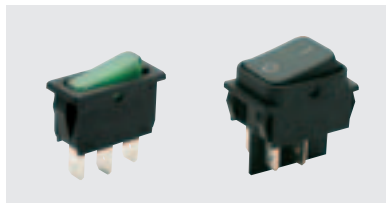

SERIES 1830

single pole and double pole
with and without indicator lamp
20 (4) A 250 V~

Appliance cut-out: 30 x 11 mm
30 x 22 mm

Pages
2.12 - 2.17



SERIES 1930

double pole, with and without indicator
lamp
with dust and water proofing
20 (4) A 250 V~

Appliance cut-out: 30 x 22 mm

Pages
2.18 - 2.19



SERIES 1855

double pole
with indicator lamp
4 (1) A 250 V~

Appliance cut-out: 19.2 x 12.9 mm

Pages
2.20 - 2.21



SERIES 1858

double pole
without indicator lamp
10 (4) A 250 V~

Appliance cut-out: 19.2 x 12.9 mm

Pages
2.22 - 2.23



SERIES 1550

single pole and double pole
with and without indicator lamp
16 (4) A 250 V~

Appliance cut-out: 27.2 x 12.2 mm

Pages
2.24 - 2.26

PUSH BUTTON SWITCHES

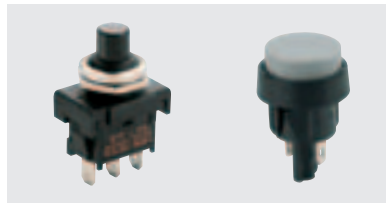

SERIES 1840 / 5000

single pole
6 (4) A 250 V~ / 4 (2) A 250 V~

Appliance cut-out: Ø 12 mm / Ø 16 mm

Pages
2.27 - 2.29

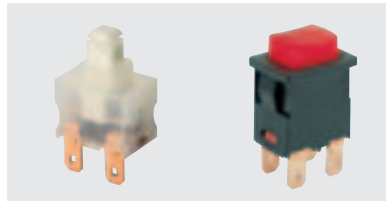

SERIES 1680

single pole and double pole
for direct and indirect actuation
12 (8) A 250 V~

Switch dimensions: 18.5 x 19 x 13 mm
Appliance cut-out: 19.2 x 12.9 mm

Pages
2.30 - 2.34

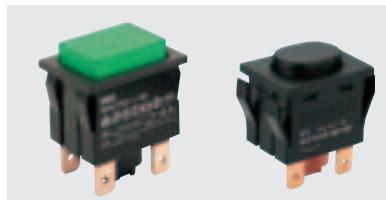

SERIES 1660 / 1670

single pole and double pole
with and without indicator lamp
16 (4) A 250 V~

Appliance cut-out: 30.0 x 22.2 mm

Pages
2.35 - 2.38

SLIDE SWITCHES



SERIES 4021

double pole
2 (0,5) A 250 V~

Switch dimensions: 14 x 26 x 16.5 mm
(H x W x D)

Pages
2.39 - 2.40

ROTARY SWITCHES



SERIES 1703

single pole up to four pole
20 (4) A 400 V~

Switch dimensions: 26 x 33 x 46 mm
(H x W x D)

Pages
2.41 - 2.42

TOGGLE SWITCHES

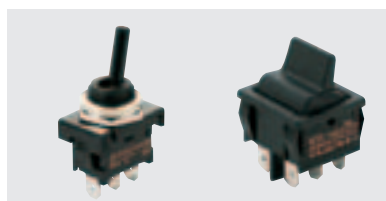

SERIES 1810 / 1820

single pole and double pole
up to 10 (4) A 250 V~

Appliance cut-out: Ø 12 mm resp.
19.2 x 12.9 mm
19.2 x 21.9 mm

Pages
2.43 - 2.46

FOOT SWITCHES

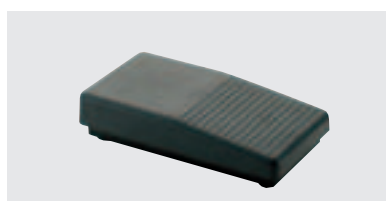

SERIES 2410

single pole and double pole
6 (2,5) A 250 V~

Dimensions: 39 x 102 x 198 mm
(H x W x D)

Page
2.47

SERIES 1900-SINGLE POLE ROCKER SWITCHES

UP TO 6 (2) A 250 V~



PRODUCT ADVANTAGES

- ◆ Reliable leaf spring contact system, proven a million times
- ◆ Attractive, slimline rocker switch in three different sizes with a silk matt surface and an abrasionproof marking
- ◆ Low space requirements due to small sizes
- ◆ Excellent actuation characteristic
- ◆ Simple snap-on assembly for appliance panel thickness of 0.75 ... 3.00 mm
- ◆ Tight fit in appliance cut-out due to tolerance compensation ribs on the switch housing
- ◆ Staked terminals for reliable plugging of connectors
- ◆ Variable connection technique (plug or solder)

SWITCHING FUNCTIONS

- ◆ Single throw switches

TERMINAL VERSIONS

- ◆ Solder/quick-connect terminal 4.8 mm

VERSIONS ON REQUEST

- ◆ Additional terminal versions
- ◆ Additional colours and markings

Standard version



Single throw switch 1901

Appliance cut-out

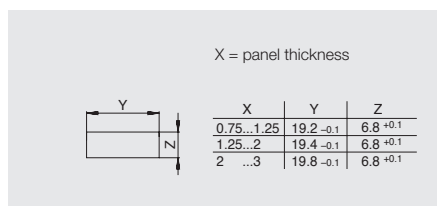

Single throw switch 1911

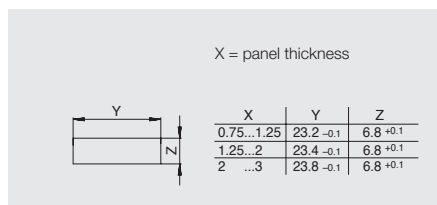

Single throw 1921

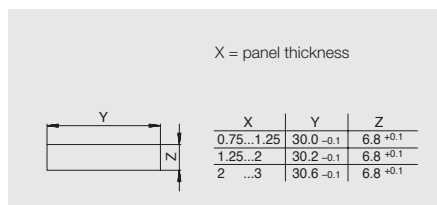

Electrical rating	6 (2) A 250 V~ 4 (1) A 250 V~ 5E4 6 A (1/8 HP) 125 - 250 V AC
Inrush current ST-switches	50 A capacitive 10 ⁴ operations
Mechanical life endurance	75 E3
Contact resistance (new state)	< 100 mΩ (12 V 1A DC)
Insulation resistance (new state)	> 100 MΩ (500 V DC between the open contacts)
High voltage resistance (new state)	750 V eff. (between the open contacts) 3750 V (reinforced insulation)
Resistance to tracking	PTI 250
Contact gap	≥ 3 mm
Insulation spacing	≥ 8 mm
Protection type	IP 40
Ambient temperature	terminal side -20 °C ...+85 °C no condensation actuating side -20 °C ...+55 °C no condensation
Storage temperature	-40 °C ...+80 °C
Actuating force	2-5 N (depending on switch size)
Flammability	UL 94 V-2
Heat and fire-resistance	850 °C (category D)
Material housing and rocker	PA
Contacts	Ag
Terminals	silver-plated
Temperature rise at the terminals (according to electrical life endurance)	max. 30 K (UL 1054) max. 55 K (EN 61058-1)
Solderability of terminals	max. 350 °C, 3 sec. (no pressure on the terminals when soldering by hand!)
Push-on force of connectors	≤ 80 N
Approval marks	
Suitable for appliances of protection class II	

The test conditions comply with EN 61058-1 and UL 1054

SINGLE POLE ST-SWITCHES



 1901.1102*



 1901.1103*

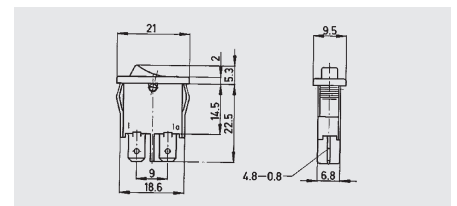

 quick-connect terminal 4.8



 1911.1102*

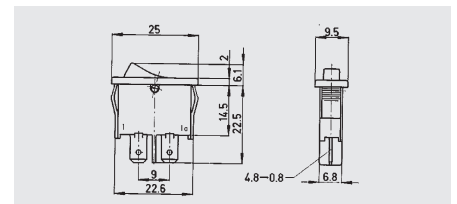

 quick-connect terminal 4.8



 1921.1102*

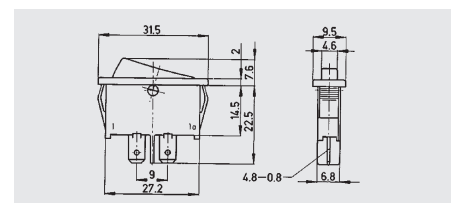

 quick-connect terminal 4.8

* Version on stock

SERIES 1800 - SINGLE POLE AND DOUBLE POLE ROCKER SWITCHES

UP TO 12 (4) A 250 V~ AND 8 (8) A 250 V~

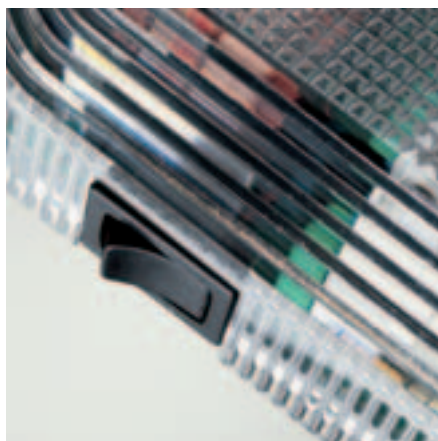

PRODUCT ADVANTAGES

- ◆ Switching principle with long life endurance due to a low friction contact system (ball), proven a 100 million times
- ◆ Attractive rocker switches with silk matt surfaces and abrasionproof markings
- ◆ High ratings up to 12 (4) A 250 V ~ resp. 8 (8) A 250 V~ and inrush current peaks up to 70A
- ◆ Suitable for ambient temperatures up to T 100/55
- ◆ High accuracy of fit between rocker and housing
- ◆ Excellent actuation characteristic
- ◆ Simple snap-on assembly for appliance panel thickness of 0.75 ... 3.00 mm
- ◆ Tight fit in appliance cut-out due to tolerance compensation ribs on the switch housing
- ◆ Staked terminals for reliable plugging of connectors

SWITCHING FUNCTIONS

- ◆ Single throw (ST) switches
- ◆ ST- switches with indicator lamp
- ◆ Double throw (DT) switches
- ◆ Double throw switches with centre-OFF
- ◆ Switches with momentary function
- ◆ Pilot lights

TERMINAL VERSIONS

- ◆ Quick-connect terminal 4.8 mm
- ◆ Solder terminal
- ◆ Straight PCB terminal
- ◆ Angled PCB-terminal

VERSIONS ON REQUEST

- ◆ With flammability according to UL 94 V-0
- ◆ With gold-plated contacts for low voltages
- ◆ With cutting contacts for applications in a dusty environment
- ◆ With additional supports for PCB assembly
- ◆ With special rocker for snapping on customized actuators

ACCESSORIES

- ◆ Protection caps against dust and splash water (see page 2.48)

STANDARD VERSIONS



APPLIANCE CUT-OUT

single pole

X = panel thickness

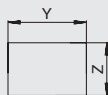

X	Y	Z
0.75...1.25	19.2 ^{-0.1}	12.9 ^{+0.1}
1.25...2	19.4 ^{-0.1}	12.9 ^{+0.1}
2 ...3	19.8 ^{-0.1}	12.9 ^{+0.1}

double pole

X = panel thickness

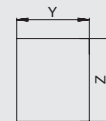

X	Y	Z
0.75...1.25	19.2 ^{-0.1}	21.9 ^{+0.1}
1.25...2	19.4 ^{-0.1}	21.9 ^{+0.1}
2 ...3	19.8 ^{-0.1}	21.9 ^{+0.1}

Electrical rating (depending on version)	8 (8) A 250 V~ 5E4 12 (4) A 250 V~ 15 A 125 - 250 V AC 3/4 HP 125 V AC 1 1/2 HP 250 V AC
Inrush current ST-switches	70 A capacitive 10 ⁴ operations
Mechanical life endurance ST / DT DT with centre-OFF	5E4 5E4
Contact resistance (new state)	< 100 mΩ (12 V, 1 A DC)
Insulation resistance (new state)	> 100 MΩ (500 V DC between the open contacts)
High voltage resistance (new state)	< 3 mm 750 V eff. (between the open contacts) ≥ 3 mm 1250 V eff. (reinforced insulation) 3750 V eff. (reinforced insulation)
Resistance to tracking	PTI 250
Contact gap ST / DT DT with centre-OFF	≥ 3 mm < 3 mm (μ)
Insulation spacing	≥ 8 mm
Protection type	IP 40
Ambient temperature Terminal side Actuating side	-20 °C ... +100 °C (no condensation) -20 °C ... + 55 °C (no condensation)
Storage temperature	-40 °C ... + 80 °C
Actuating force	3-8 N (depending on the switching function)
Flammability	UL 94 V-2
Heat and fire resistant	850 °C (category D)
Material housing and rocker rocker illuminated	PA PC
Contacts	Ag
Terminals	silver-plated
Temperature rise at the terminals (according to electrical life endurance)	max. 30 K (UL 1054) max. 55 K (EN 61058-1)
Solderability of terminals	max. 350 °C, 3 sec. (no pressure when soldering by hand!)
Push-on force of connectors	≤ 80 N
Approval marks	or
Suitable for appliances of protection class II	

SERIES 1800 - SINGLE POLE AND DOUBLE POLE ROCKER SWITCHES

UP TO 12 (4) A 250 V~ AND 8 (8) A 250 V~

SINGLE POLE ST-SWITCHES

with indicator lamp

10 (4) A 250 V~
 6 (4) A 250 V~ 5E4
 5/50 A 250 V~
 T 100/55
 6 A (1/2 HP) 250 V AC

ST-switches for 125 V AC on request



1800.1102*
 1800.0102



1800.1108*
 1800.0108



1800.1104*

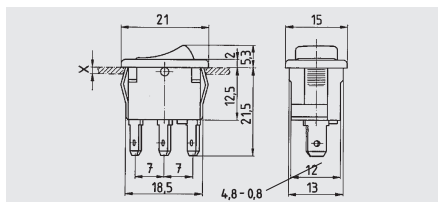

quick-connect terminal 4.8

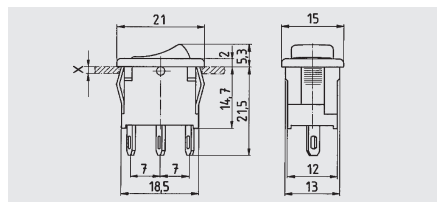

solder terminal

DOUBLE POLE ST-SWITCHES

with indicator lamp

10 (4) A 250 V~
 6 (4) A 250 V~ 5E4
 5/50 A 250 V~
 T 100/55
 6 A (1/2 HP) 250 V AC

ST-switches with indicator lamp for
 12 (4) A 250 V~ resp. 8 (8) A 250 V~,
 for 125 V AC and for 125 V - 250 V AC
 on request



1805.7110*
 1805.6102



1805.7104*



1805.7109*
 1805.6108

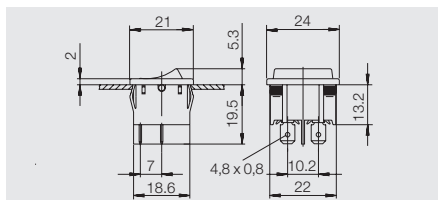

quick-connect terminal 4.8

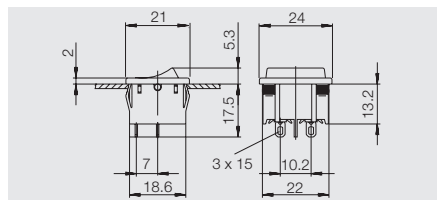

solder terminal

SINGLE POLE COMBINATION

10 (4) A 250 V~
 6 (4) A 250 V~ 5E4
 T 100/55

Additional switching functions on request



ST-switch / ST-switch
 1806.1102*



ST-switch / Pilot light
 1806.1402

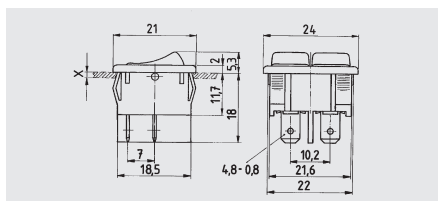
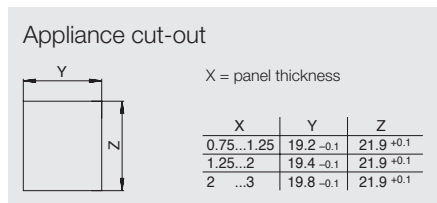

quick-connect terminal 4.8

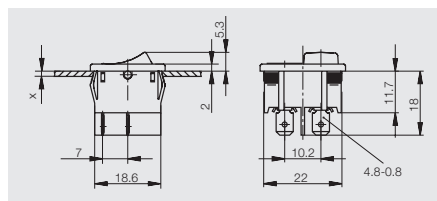

quick-connect terminal 4.8

SINGLE POLE ST-SWITCHES

12 (4) A 250 V~
 8 (8) A 250 V~ 5E4
 5/70 A 250 V~
 T 100/55
 15 A (3/4 HP) 125 V AC
 15 A (1 1/2 HP) 250 V AC



1801.1121*
 1801.0121*



1801.1908*
 1801.0136*

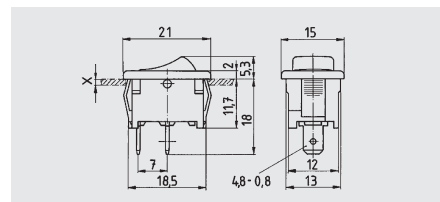

quick-connect terminal 4.8

10 (4) A 250 V~
 6 (4) A 250 V~ 5E4
 5/50 A 250 V~
 T 100/55
 6 A (1/4 HP) 125 V AC
 6 A (1/2 HP) 250 V AC



1801.1101
 1801.6101



1801.1102*
 1801.6102*
 1801.5102



1801.1119*
 1801.6112



1801.1146*
 1801.6115*
 1801.2106



1801.1139*
 1801.0179



1801.1903

SINGLE POLE ST-SWITCHES

with installed dust protection cap
 10 (4) A 250 V~
 6 (4) A 250 V~ 5E4
 5/50 A 250 V~
 T 100/55
 6 A (1/4 HP) 125 V AC
 6 A (1/2 HP) 250 V AC



1801.1403*

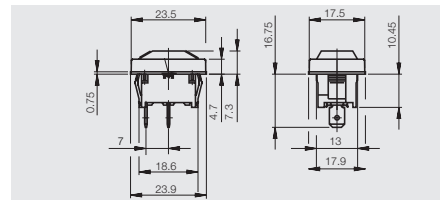

quick-connect terminal 4.8

DOUBLE POLE ST-SWITCHES

12 (4) A 250 V~
 8 (8) A 250 V~ 5E4
 5/70 A 250 V~
 T 100/55
 15 A (3/4 HP) 125 V AC
 15 A (1 1/2 HP) 250 V AC



1802.1123*
 1802.0130*

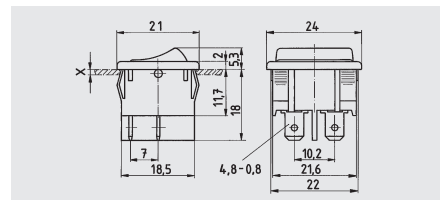

quick-connect terminal 4.8

10 (4) A 250 V~
 6 (4) A 250 V~ 5E4
 5/50 A 250 V~
 T 100/55
 6 A (1/4 HP) 125 V AC
 6 A (1/2 HP) 250 V AC



1802.1108*
 1802.6103*
 1802.2104
 1802.5103*



1802.1101
 1802.0101



1802.1102*

* Version on stock

SERIES 1800 - SINGLE POLE AND DOUBLE POLE ROCKER SWITCHES

UP TO 12 (4) A 250 V~ AND 8 (8) A 250 V~

SINGLE POLE DT-SWITCHES

10 (4) A 250 V~
6 (4) A 250 V~ 5E4
T 100/55
6 A (1/4 HP) 125 V AC
6 A (1/2 HP) 250 V AC

DT-switches with  and -approval marks for 10 A on request



 1803.1102*
 1803.6102*
 1803.2102
 1803.5102

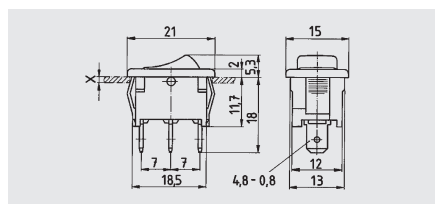

 quick-connect terminal 4.8

DOUBLE POLE DT-SWITCHES

10 (4) A 250 V~
6 (4) A 250 V~ 5E4
T 100/55
6 A (1/4 HP) 125 V AC
6 A (1/2 HP) 250 V AC

DT-switches with  and -approval marks for 10 A on request



 1804.1102*
 1804.6102*
 1804.2102

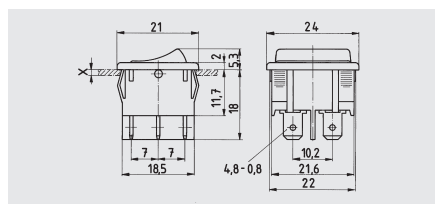

 quick-connect terminal 4.8



SINGLE POLE DT-SWITCHES

with centre-OFF



6 (2) A 250 V~ μ
T 100/55
6 A (1/8 HP) 125-250 V AC

Momentary function on one side on request





without momentary
 1808.1102*
 1808.0102*
 1808.2102*



without momentary
 1808.1103*
 1808.0111*



momentary on both sides
 1808.1302*
 1808.0302*
 1808.2302*

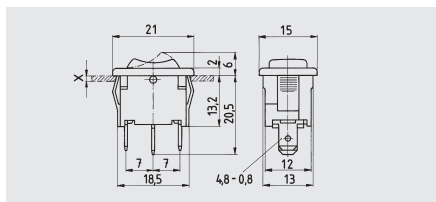

 quick-connect terminal 4.8

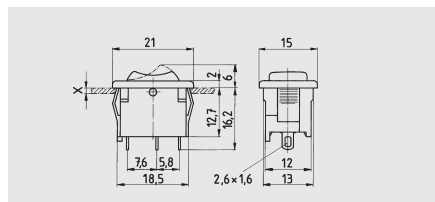

 solder terminal

DOUBLE POLE DT-SWITCHES

with centre-OFF

6 (2) A 250 V~ μ
T 100/55
6 A (1/8 HP) 125-250 V AC

Momentary function from one side on request



without momentary
 1809.1102*



momentary on both sides
 1809.1302*

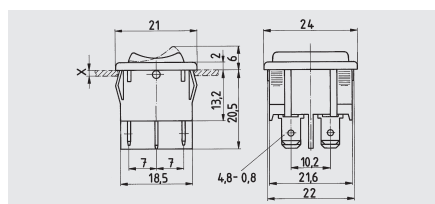

 quick-connect terminal 4.8

SINGLE POLE WITH MOMENTARY FUNCTION

4 (2) A 250 V~
 T 100/55
 6 A (1/10 HP) 125 V AC
 4 A (1/10 HP) 250 V AC



normally closed
 □ 1801.1302*



normally open
 □ 1801.1202*
 □ 1801.0202*



DT momentary
 □ 1803.1202*
 □ 1803.0202*

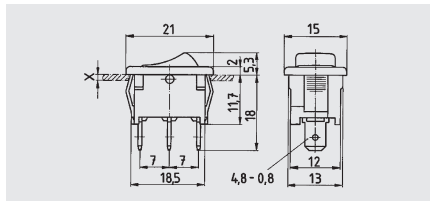

□ quick-connect terminal 4.8

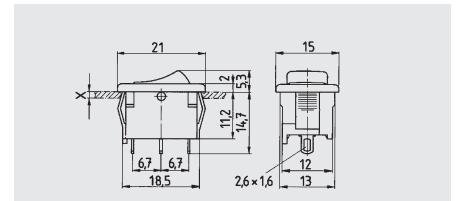

□ solder terminal

DOUBLE POLE WITH MOMENTARY FUNCTION

4 (2) A 250 V~
 T 100/55
 6 A (1/10 HP) 125 V AC
 4 A (1/10 HP) 250 V AC



normally open
 □ 1802.1221*

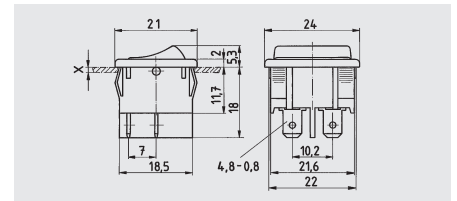

□ quick-connect terminal 4.8

DOUBLE POLE ST-SWITCHES

for direct connection to the mains

10 (4) A 250 V~
 6 (4) A 250 V~ 5E4
 5/50 A 250 V~
 T 100/55
 6 A (1/4 HP) 125 V AC
 6 A (1/2 HP) 250 V AC



□ □ 1802.3102*

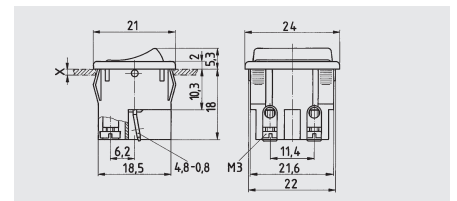

□ □ quick-connect 4.8 and bush terminals

Higher electrical rating on request

PILOT LIGHTS

Pilot lights with neon lamps and resistor for 230 V~



Pilot lights for 125 V AC on request



□ 1807.1102*



□ 1807.1108

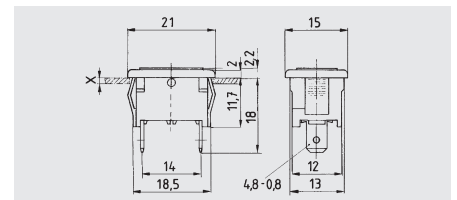

□ quick-connect terminal 4.8

* Version on stock

SERIES 1830 - SINGLE POLE AND DOUBLE POLE

ROCKER SWITCHES UP TO 20 (4) A 250 V~



Standard version and appliance cut-out



single pole

X = panel thickness



X	Y	Z
0.75...1.25	30.0 ^{-0.1}	11 ^{+0.1}
1.25...2	30.2 ^{-0.1}	11 ^{+0.1}
2 ...3	30.6 ^{-0.1}	11 ^{+0.1}

double pole

X = panel thickness

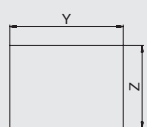

X	Y	Z
0.75...1.25	30.0 ^{-0.1}	22 ^{+0.2}
1.25...2	30.2 ^{-0.1}	22 ^{+0.2}
2 ...3	30.6 ^{-0.1}	22 ^{+0.2}

PRODUCT ADVANTAGES

- ◆ Switching principle with long life endurance due to a low friction contact system (ball), proven a 100 million times
- ◆ Attractive rocker switches with a silk matt surface and an abrasionproof marking
- ◆ High electrical ratings up to 20 (4) A 250 V~ and inrush current peaks up to 120 A
- ◆ Suitable for ambient temperatures up to T 105/55
- ◆ Excellent actuation characteristic
- ◆ Simple snap-on assembly for appliance panel thickness of 0.75 ... 3.00 mm
- ◆ Tight fit in appliance cut-out due to tolerance compensation ribs on the switch housing
- ◆ Locked terminals for safe plugging of the connectors

SWITCHING FUNCTIONS

- ◆ Single throw (ST) switches
- ◆ ST-switches with indicator lamp
- ◆ Double throw (DT) switches
- ◆ DT-switches with centre-OFF
- ◆ Switches with momentary function
- ◆ Pilot lights

TERMINAL VERSIONS











- ◆ Quick-connect terminal 4.8 mm
- ◆ Quick-connect terminal 6.3 mm
- ◆ Solder terminal
- ◆ Straight PCB-terminal
- ◆ Angled PCB-terminal

VERSIONS ON REQUEST

- ◆ Flammability according to UL 94 V-0
- ◆ Double pole switches with integrated dust protection (see page 2.17)
- ◆ With gold contacts for low voltages
- ◆ Additional colours and markings

ACCESSORIES

- ◆ Protection caps against dust and splash water for double pole switches (Page 2.48)

Electrical rating (depending on version)	20 (4) A 250 V~ 10 (8) A 250 V~ 5E4 16 A 125 - 250 V AC 1/3 HP 125 V AC 1 HP 250 V AC
Inrush current ST-switches	120 A capacitive 10 ⁴ operations
Mechanical life endurance ST / DT DT with centre-OFF	1E5 5E4
Contact resistance (new state)	< 100 mΩ (12 V, 1A DC)
Insulation resistance (new state)	> 100 MΩ (500 V DC between the open contacts)
High voltage resistance (new state)	1250 V eff. (between the open contacts) 3750 V eff. (reinforced insulation)
Resistance to tracking	PTI 250
Contact gap	≥ 3 mm
Insulation spacing	≥ 8 mm
Protection type	IP 40
Ambient temperature	-20 ... +105 °C no condensation
Terminal side switch not illuminated	-20 ... +85 °C no condensation
Terminal side switch illuminated	-20 ... +55 °C no condensation
Actuating side	-20 ... +55 °C no condensation
Storage temperature	-40 ... +80 °C
Actuating force	3-8 N (depending on the switching function)
Flammability	UL 94 V-2
Heat and fire-resistance	850 °C (category D)
Material housing and rocker rocker illuminated	PA PC
Contacts	Ag
Terminals	silver-plated
Temperature rise at the terminals (according to electrical life endurance)	max. 30 K (UL 1054) max. 55 K (EN 61058-1)
Solderability of terminals	max. 350 °C, 3 sec. (without pressure on the terminals when soldering by hand!)
Push-on force of connectors	≤ 80 N
Approval marks	 or         
Suitable for appliances of protection class II	

The test conditions comply with EN 610581-1 and UL 1054

INSTALLATION EXAMPLE FOR

switches of the series 1830 with design frame

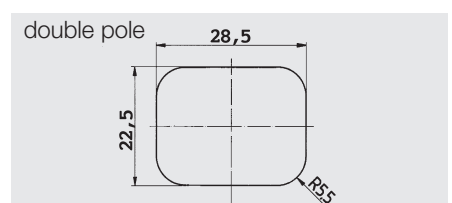
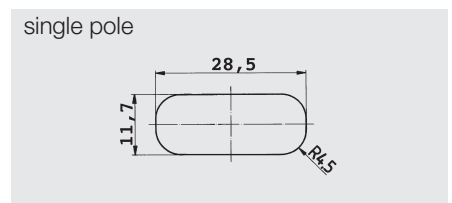
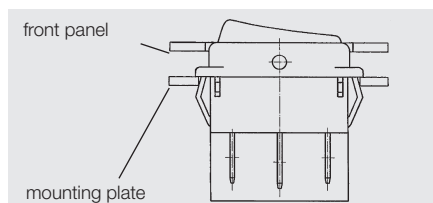

SERIES 1830 - HIGH INRUSH SINGLE POLE AND DOUBLE POLE

ROCKER SWITCHES UP TO 20 (4) A 250 V~

SINGLE POLE ST-SWITCHES

illuminated

20 (4) A 250 V~
 10 (8) A 250 V~ 5E4
 5/120 A 250 V~
 T 85/55
 16 A (1 HP) 250 V AC

Switches for 125 V AC on request



6.3 1830.3111



6.3 1830.3112*



6.3 1830.3118*



6.3 1830.8112*

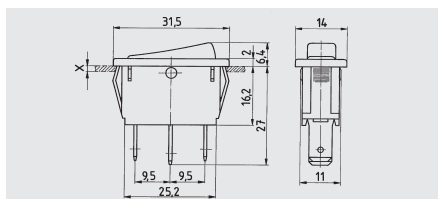

quick-connect terminal 6.3

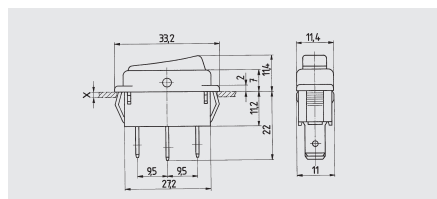

quick-connect terminal 6.3

DOUBLE POLE ST-SWITCHES

illuminated

20 (4) A 250 V~
 10 (8) A 250 V~ 5E4
 5/120 A 250 V~
 T 85/55
 16 A (1 HP) 250 V AC

Switches for 125 V AC or 400 V AC on request



6.3 1835.3114



6.3 1835.3112*



6.3 1835.3111



6.3 1835.3118*

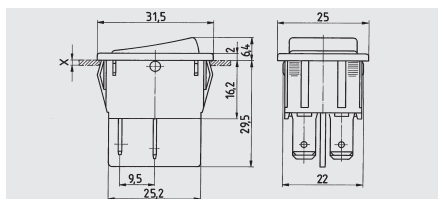

quick-connect terminal 6.3

SINGLE POLE ST-SWITCHES

20 (4) A 250 V~
 10 (8) A 250 V~ 5E4
 5/120 A 250 V~
 T 105/55
 16 A (1/3 HP) 125 V AC
 16 A (1 HP) 250 V AC



6.3 1831.3312*



6.3 1831.3313*
 1831.0115



6.3 1831.3933*
 1831.0114*



6.3 1831.8112*

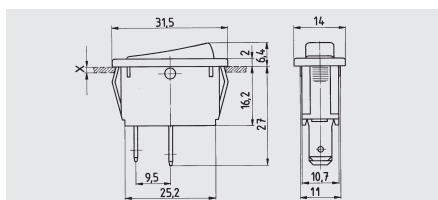

quick-connect terminal 6.3

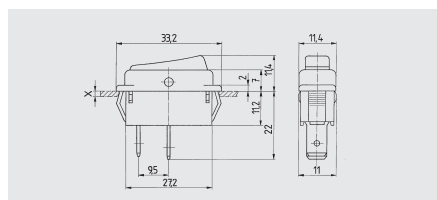

quick-connect terminal 6.3

DOUBLE POLE ST-SWITCHES

20 (4) A 250 V~
 10 (8) A 250 V~ 5E4
 5/120 A 250 V~
 T 105/55
 16 A (1/3 HP) 125 V AC
 16 A (1 HP) 250 V AC



6.3 1832.3312* 6.3 1832.3311* 6.3 1832.8112*

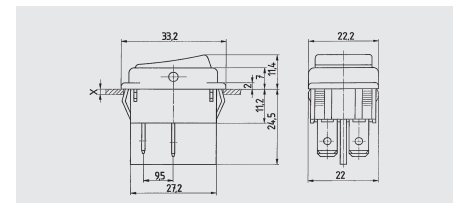
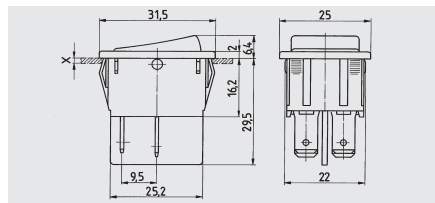

quick-connect terminal 6.3

quick-connect terminal 6.3

SINGLE POLE DT-SWITCHES

10 (4) A 250 V~
 6 (4) A 250 V~ 5E4
 T 105/55
 6 A (1/4 HP) 125 V AC
 6 A (1/2 HP) 250 V AC



6.3 1833.3302* 6.3 1833.3305* 6.3 1833.8102

16 (4) A 250 V~
 T 105/55
 16 A (1/3 HP) 125 V AC
 16 A (1/2 HP) 250 V AC

6.3 1833.3312

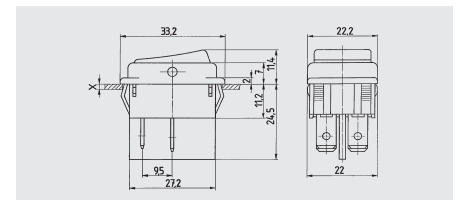
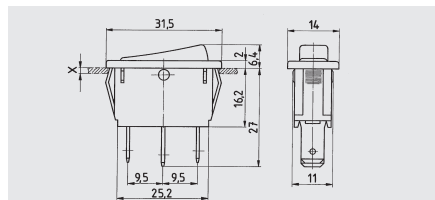

quick-connect terminal 6.3

quick-connect terminal 6.3

DOUBLE POLE DT-SWITCHES

10 (4) A 250 V~
 6 (4) A 250 V~ 5E4
 T 105/55
 6 A (1/4 HP) 125 V AC
 6 A (1/2 HP) 250 V AC

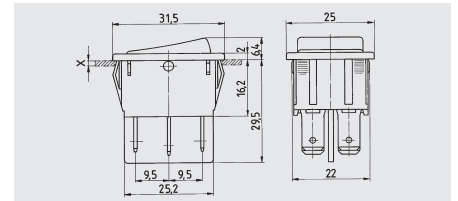

6.3 1834.3302* 6.3 1834.3309* quick-connect terminal 6.3

16 (4) A 250 V~
 T 105/55
 16 A (1/3 HP) 125 V AC
 16 A (1/2 HP) 250 V AC

6.3 1834.3312

SERIES 1830 - HIGH INRUSH SINGLE POLE AND DOUBLE POLE

ROCKER SWITCHES UP TO 20 (4) A 250 V~

SINGLE POLE DT-SWITCHES

with centre-OFF

6 (4) A 250 V~

T 105/55

6 A (1/8 HP) 125-250 V AC



without momentary

□ 6.3 1838.3502*

□ 4.8 1838.1502*



momentary on both sides

□ 6.3 1838.3402*

□ 4.8 1838.1402*



without momentary

□ 4.8 1838.1509*

16 (4) A 250 V~

T 105/55

16 A (1/3 HP) 125 V AC

16 A (1/2 HP) 250 V AC

□ 6.3 1838.3512

□ 6.3 1838.3412

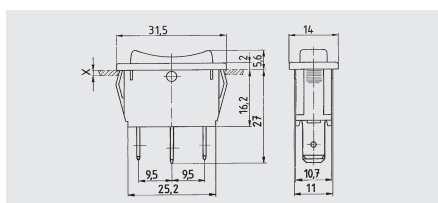

□ quick-connect terminal 6.3

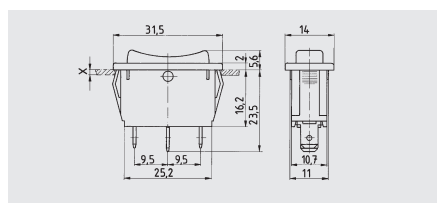

□ quick-connect terminal 4.8

Momentary function on one side on request

DOUBLE POLE DT-SWITCHES

with centre-OFF

6 (4) A 250 V~

T 105/55

6 A (1/8 HP) 125-250 V AC



without momentary

□ 6.3 1839.3502*

□ 4.8 1839.1502



momentary on both sides

□ 6.3 1839.3402*

□ 4.8 1839.1402*



momentary on both sides

□ 4.8 1839.1407*

16 (4) A 250 V~

T 105/55

16 A (1/3 HP) 125 V AC

16 A (1/2 HP) 250 V AC

□ 6.3 1839.3512

□ 6.3 1839.3412

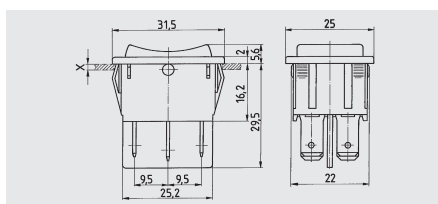

□ quick-connect terminal 6.3

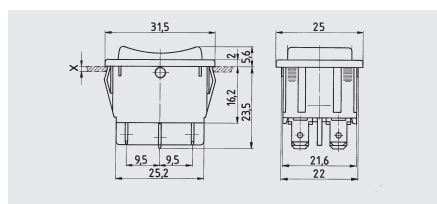

□ quick-connect terminal 4.8

Momentary function on one side on request

SWITCHES WITH MOMENTARY FUNCTION

4 (2) A 250 V~

T 105/55

6 A (1/10 HP) 125 V AC

4 A (1/10 HP) 250 V AC



normally open

□ 6.3 1831.3402



DT momentary

□ 6.3 1833.3402

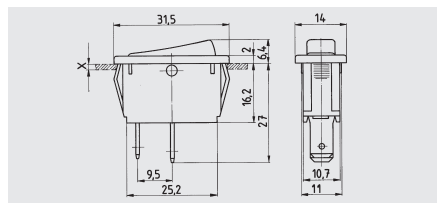

□ quick-connect terminal 6.3

DOUBLE POLE WITH MOMENTARY FUNCTION

4 (2) A 250 V~
 T 105/55
 6 A (1/10 HP) 125 V AC
 4 A (1/10 HP) 250 V AC



normally open
 6.3 1832.3407



DT momentary
 6.3 1834.3402*

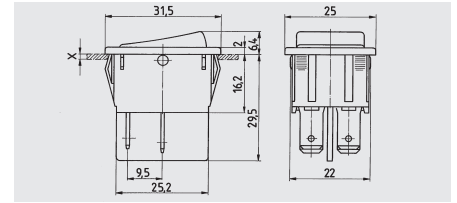

quick-connect terminal 6.3

PILOT LIGHTS

Pilot lights with neon lamp and resistor for 230 V~



Pilot light for 125 V AC according to UL and other colours on request.



6.3 1837.3102*

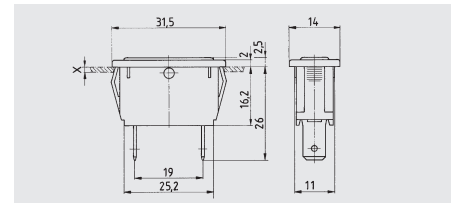

quick-connect terminal 6.3 resp. 4.8



6.3 1837.8102*



6.3 1837.8108

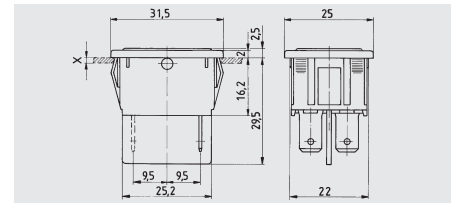

quick-connect terminal 6.3

SERIES 1830 - ROCKER SWITCHES WITH INTEGRATED DUST PROTECTION

Several double pole versions with integrated dust protection are available in the 1830 series.

The diagram opposite shows how the seal in the switch offers a better protection for the contact system against dust penetration.

On request we will supply the switch versions with this dust protection.

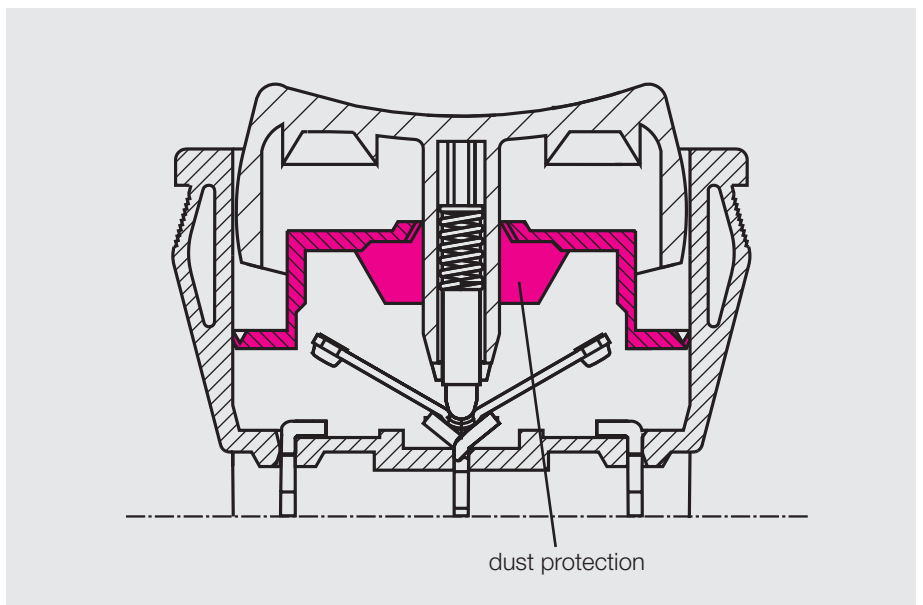

* Version on stock

SERIES 1930 - SINGLE AND DOUBLE POLE ROCKER SWITCHES UP TO 20 (4) A 250 V~ WITH IP 65 DUST AND SPLASH WATER PROOFING



PRODUCT ADVANTAGES

- ◆ Switching principle proven a 100 million times with long life endurance due to a low friction contact
- ◆ Modern rocker design with integrated seal for dust and splash water proofing up to IP 65, an additional protection cap is not necessary
- ◆ High electrical ratings up to 20 (4) A 250 V~ and inrush currents up to 120 A
- ◆ Single pole and double pole versions in the same size and mounting depth
- ◆ Excellent actuation characteristic
- ◆ Simple snap-on assembly for appliance panel thickness of 0.75...3.00 mm
- ◆ Tight fit in appliance cut-out due to tolerance compensation ribs on the switch housing
- ◆ Locked terminals for safe plugging

SWITCHING FUNCTIONS



- ◆ ST-switches
- ◆ ST-switches with indicator lamp
- ◆ DT-switches with centre-OFF
- ◆ DT-switches
- ◆ Switches with momentary function

TERMINAL VERSIONS

- ◆ Quick-connect terminal 6.3 mm

VERSIONS ON REQUEST

- ◆ For 125 V AC
- ◆ DT-switches with centre-OFF
- ◆ DT-switches
- ◆ Switches with momentary function

Electrical rating (depending on version)	20 (4) A 250 V~ 10 (8) A 250 V~ 5E4 16 A 125 - 250 V AC 1/3 HP 125 V AC 1 HP 250 V AC
Inrush current ST-switches	120 A capacitive 10 ⁴ operations
Mechanical life endurance	50E3
Contact resistance (new state)	< 100 mΩ (12 V, 1A DC)
Insulation resistance (new state)	> 100 MΩ (500 V DC between the open contacts)
High voltage resistance (new state)	1250 V eff. (between the open contacts) 3750 V eff. (reinforced insulation)
Resistance to tracking	PTI 250
Contact gap	≥ 3 mm
Insulation spacing	≥ 8 mm
Protection type	IP 65
Ambient temperature terminal side	-30 ... +105 °C no condensation
actuating side	-30 ... +55 °C no condensation
Storage temperature	-40 ... +80 °C
Actuating force	3-8 N (depending on the switching function)
Flammability	UL 94 V-2
Heat and fire-resistance	850 °C (category D)
Material housing and rocker	PA
rocker illuminated	PC
Contacts	Ag
Terminals	silver-plated
Temperature rise at the terminals (according to electrical life endurance)	max. 30 K (UL 1054) max. 55 K (EN 61058-1)
Push-on force of connectors	≤ 80 N
Approval marks	  
Suitable for appliances of protection class II	

The test conditions comply with EN 61058-1 and UL 1054

STANDARD VERSION

single pole and double pole

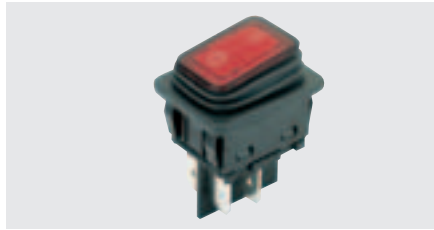

appliance cut-out

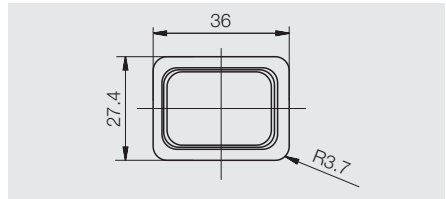
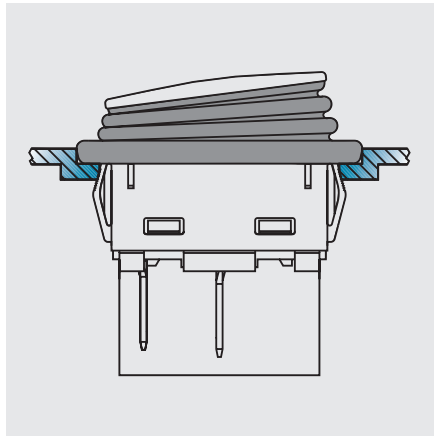
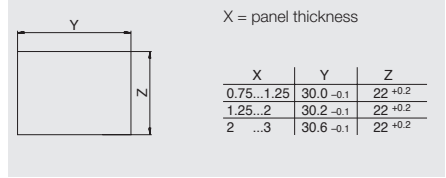

DOUBLE POLE ST-SWITCHES

with indicator lamp

20 (4) A 250 V~
 10 (8) A 250 V~ 5E4
 5/120 A 250 V~
 T 105/55
 16 A (1 HP) 250 V AC



6.3 1935.3112*

6.3 1935.3113*

6.3 1935.3114*

6.3 1935.3118*

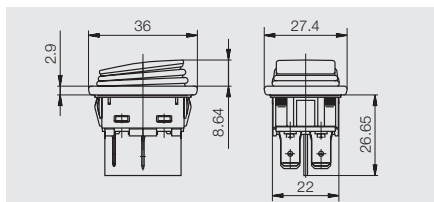

quick-connect terminal 6.3

DOUBLE POLE ST-SWITCHES

20 (4) A 250 V~
 10 (8) A 250 V~ 5E4
 5/120 A 250 V~
 T 105/55
 16 A (1 HP) 250 V AC



6.3 1932.3112*

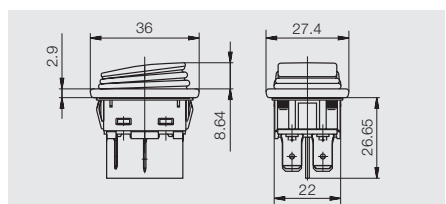

quick-connect terminal 6.3

* Version on stock

SERIES 1855 - DOUBLE POLE ROCKER SWITCHES WITH

INDICATOR LAMP UP TO 4 (1) A 250 V~



PRODUCT ADVANTAGES

- ◆ Reliable leaf spring contact system, proven a million times
- ◆ Double pole rocker switches with indicator lamp in a very small size
- ◆ Rocker switches with a silk matt surface and an abrasion proof marking
- ◆ High accuracy between rocker and housing
- ◆ Excellent actuation characteristic
- ◆ Simple snap-on assembly for appliance panel thickness of 0.75 ... 3.00 mm
- ◆ Tight fit in appliance cut-out due to tolerance compensation ribs on the switch housing
- ◆ Staked terminals for reliable plugging of connectors

SWITCHING FUNCTIONS

- ◆ ST-switch with indicator lamp

TERMINAL VERSIONS

- ◆ Quick-connect terminal 4.8 mm
- ◆ Solder terminal

VERSIONS ON REQUEST

- ◆ For 125 V AC
- ◆ Additional colours and markings

ACCESSORIES

- ◆ Protection caps against dust and splash water (see page 2.48)

Standard version



Appliance cut-out

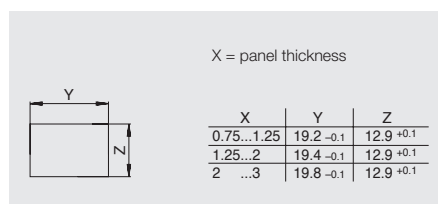

Electrical rating	4 (1) A 250 V~ 4 A 250 V AC 1/10 HP 250 V AC
Inrush current	50 A capacitive 10 ⁴ operations
Mechanical life endurance	5E4
Contact resistance (new state)	< 100 mΩ (12 V, 1A DC)
Insulation resistance (new state)	> 100 MΩ (500 V DC between the open contacts)
High voltage resistance (new state)	1250 V eff. (between the open contacts) 3750 V eff. (reinforced insulation)
Resistance to tracking	PTI 250
Contact gap	≥ 3 mm
Insulation spacing	≥ 8 mm
Protection type	IP 40
Ambient temperature	terminal side -20 ... +85 °C no condensation actuating side -20 ... +55 °C no condensation
Storage temperature	-40 ... +80 °C
Actuating force	5 N
Flammability	UL 94 V-2
Heat and fire-resistance	850 °C (category D)
Material housing and rocker	PA
Contacts	Ag
Terminals	silver-plated
Temperature rise at the terminals (according to electrical life endurance)	max. 30 K (UL 1054) max. 55 K (EN 61058-1)
Solderability of terminals	max. 350 °C, 3 sec. (no pressure on the terminals when soldering by hand!)
Push-on force of connectors	≤ 80 N
Approval marks	
Suitable for appliances of protection class II	



The test conditions comply with EN 61058-1 and UL 1054

DOUBLE POLE ST-SWITCHES

with indicator lamp
4 (1) A 250 V~
4 A 250 V AC
1/10 HP 250 V AC

Switches for 125 V AC on request



 4.8 1855.1102*
 1855.0102*

 4.8 1855.1108*
 1855.0108*

 4.8 1855.1104*

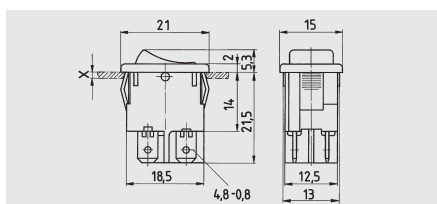

 quick-connect terminal 4.8

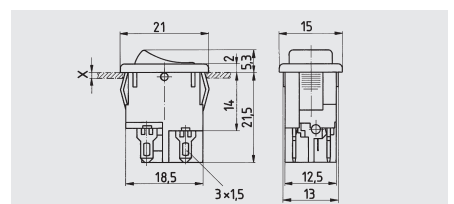

 solder terminal

SERIES 1858 - DOUBLE POLE ROCKER SWITCHES UP TO 10(4)A

INRUSH CURRENTS UP TO 100 A

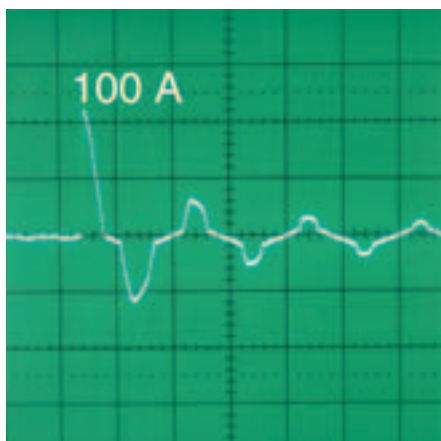

PRODUCT ADVANTAGES

- ◆ Switching system with long life endurance, proven a million times
- ◆ Attractive rocker switches with a silk matt surface and an abrasionproof marking
- ◆ Material immediately self-extinguishing (UL 94 V-0)
- ◆ Suitable for inrush currents 100 A (capacitive according EN 61058-1) and ambient temperatures up to T 100/55
- ◆ Single pole and double pole versions in the same size and mounting depth
- ◆ Simple snap-on assembly for appliance panel thickness of 0.75 ... 3.00 mm
- ◆ Tight fit in appliance cut-out due to compensation ribs on the switch housing
- ◆ Double fixed terminals for safe plugging of the connectors

SWITCHING FUNCTIONS

- ◆ ST-switch

TERMINAL VERSIONS

- ◆ Quick-connect terminal 4.8 mm
- ◆ Solder terminal
- ◆ PC-terminal
- ◆ Angled PC-terminal

VERSIONS ON REQUEST

- ◆ Single pole switches
- ◆ Additional colours and markings

ACCESSORIES

- ◆ Protection cap against dust and splash water (see page 2.48)

Standard version and appliance cut-out

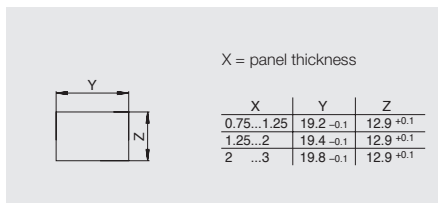

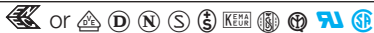
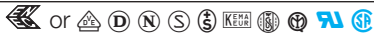
Electrical rating	10 (4) A 250 V~ 6 (4) A 250 V~ 5E4 5/100 A 250 V~ 12 A 125 - 250 V AC 1/3 HP 125 V AC 1/2 HP 250 V AC
Inrush current	100 A capacitive 10 ⁴ operations
Mechanical life endurance	1E5
Contact resistance (new state)	< 100 mΩ (12 V, 1A DC)
Insulation resistance (new state)	> 100 MΩ (500 V DC between the open contacts)
High voltage resistance (new state)	1250 V eff. (between the open contacts) 3750 V eff. (reinforced insulation)
Resistance to tracking	PTI 250
Contact gap	≥ 3 mm
Insulation spacing	≥ 8 mm
Protection type	IP 40
Ambient temperature	terminal side -20 ... +100 °C no condensation actuating side -20 ... +55 °C no condensation
Storage temperature	-40 ... +80 °C
Actuating force	3 N
Flammability	
Rocker and housing black	UL 94 V-0
Rocker and housing other colours	UL 94 V-2
Heat and fire-resistance	850 °C (category D)
Material housing and rocker	PA
Contacts	Ag
Terminals	silver-plated
Temperature rise at the terminals (according to electrical life endurance)	max. 30 K (UL 1054) max. 55 K (EN 61058-1)
Solderability of terminals	max. 350 °C, 3 sec. (no pressure on the terminals when soldering by hand!)
Push-on force of connectors	≤ 80 N
Approval marks	 or 
Suitable for appliances of protection class II	

The test conditions comply with EN 61058-1 and UL 1054



DOUBLE POLE ST-SWITCHES

10 (4) A 250 V~
6 (4) A 250 V~ 5E4
5/100 A 250 V~
12 A (1/3 HP) 125 V AC
12 A (1/2 HP) 250 V AC



 1858.1102*
 1858.4202*



 1858.1103*
 1858.0103*



 1858.1104*
 1858.0104
 1858.4205*

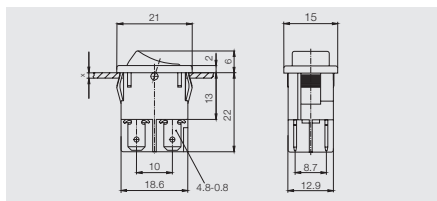

 quick-connect terminal 4,8

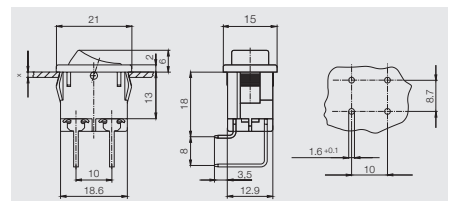

 angled PC-terminal

* Version on stock

SERIES 1550 - SINGLE POLE AND DOUBLE POLE ROCKER SWITCHES

UP TO 16 (4) A 250 V~ INRUSH CURRENTS UP TO 100 A

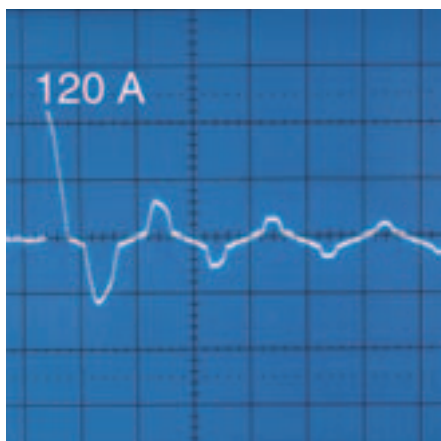

PRODUCT ADVANTAGES

- ◆ Single pole and double pole rocker switches in the same size with ratings up to 16 (4) A 250 V~
- ◆ Inrush currents up to 100 A
- ◆ Excellent actuation characteristic due to snap-action contacting system
- ◆ Forced mechanical opening in the event that contacts weld together under extremely high switching loads
- ◆ Silk matt surface with an abrasionproof marking
- ◆ High accuracy of fit between rocker and housing
- ◆ Prominent lighting by lens effect
- ◆ For ambient temperatures up to T 100/55
- ◆ Simple snap-on assembly for appliance panel thickness of 0.80 ... 5.00 mm
- ◆ Tight fit in appliance cut-out due to tolerance compensation ribs on the switch housing
- ◆ Locked terminals for safe plugging of the connectors

SWITCHING FUNCTIONS SINGLE AND DOUBLE POLE

- ◆ ST-switch
- ◆ ST-switch with indicator lamp
- ◆ Switch with momentary function

TERMINAL VERSIONS

- ◆ Quick-connect terminal 6.3 mm
- ◆ Solder terminal
- ◆ PC-terminal
- ◆ Angled PC-terminal

VERSIONS ON REQUEST

- ◆ With flammability according to UL 94 V-0
- ◆ For inrush currents up to 120 A
- ◆ With gold contacts for low voltages
- ◆ Switches with additional supports for PCB assembly

Standard versions



Appliance cut-out

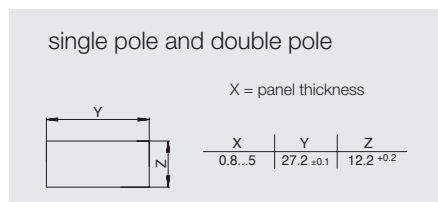

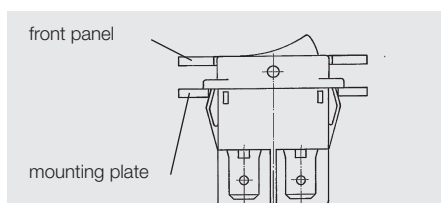

Installation example

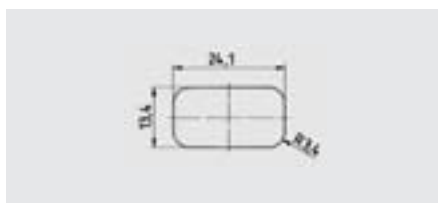

Appliance cut-out



Electrical rating	16 (4) A 250 V~ 10 (4) A 250 V~ 5E4 5/100 A 250 V~ 16 A 125 - 250 V AC 1 HP 125 V AC 2 HP 250 V AC
Inrush current ST-switches	100 A capacitive 10 ⁴ operations
Mechanical life endurance	≥ 5E4
Contact resistance (new state)	< 100 mΩ (12 V, 1A DC)
Insulation resistance (new state)	> 100 MΩ (500 V DC between the open contacts)
High voltage resistance (new state)	1250 V eff. (between the open contacts) 3750 V eff. (reinforced insulation)
Resistance to tracking	PTI 250
Contact gap	≥ 3 mm
Insulation spacing	≥ 8 mm
Protection type	IP 40
Ambient temperature	terminal side -20 °C ... +100 °C no condensation actuating side -20 °C ... + 55 °C no condensation
Storage temperature	-40 °C ... + 80 °C
Actuating force	3-5 N
Flammability	UL 94 V-2
Heat and fire-resistance	850 °C (category D)
Material housing and rocker rocker illuminated	PA PA/PC
Contacts	Ag
Terminals	CuZn resp. silver-plated
Temperature rise at the terminals (according to electrical life endurance)	max. 30 K (UL 1054) max. 55 K (EN 61058-1)
Solderability of terminals	max. 350 °C, 3 sec. (no pressure on the terminals when soldering by hand!)
Push-on force of connectors	≤ 80 N
Approval marks	  
Suitable for appliances of protection class II	

The test conditions comply with EN 61058-1 and UL 1054

FORCED CONTACT OPENING

The series 1550 is designed in order to force mechanically welded contacts (melting under heat) which may occur at extremely high switching loads to open.

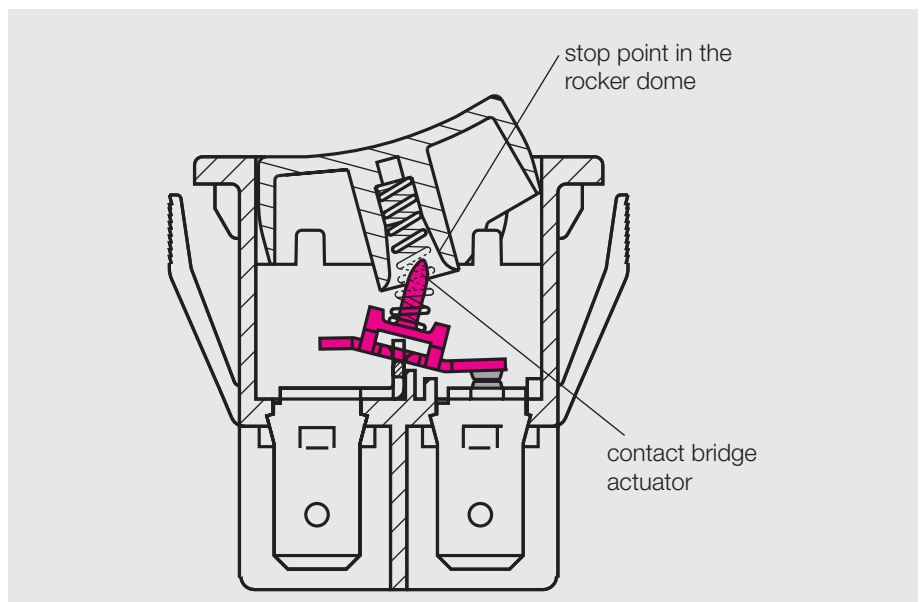

SERIES 1550 - SINGLE POLE AND DOUBLE POLE ROCKER SWITCHES

UP TO 16 (4) A 250 V~ INRUSH CURRENTS UP TO 100 A

ST-SWITCHES

with indicator lamp

16 (4) A 250 V~
10 (4) A 250 V~ 5E4
5/100A 250 V~
16 A (2 HP) 250 V AC

Switches for 125 V AC and single pole versions on request



double pole
☐ 1555.3104*



double pole
☐ 1555.3102*



double pole
☐ 1555.3108*



double pole
☐ 1555.3604

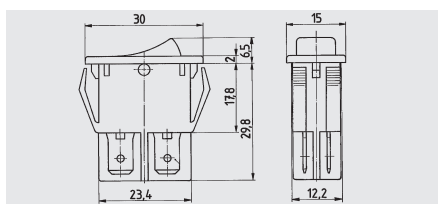

☐ quick-connect terminal 6.3

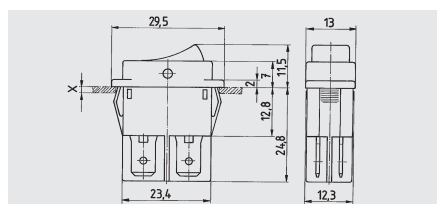

☐ quick-connect terminal 6.3

ST-SWITCHES

16 (4) A 250 V~
10 (4) A 250 V~ 5E4
5/100A 250 V~
16 A 125 - 250 V AC
1 HP 125 V AC
2 HP 250 V AC



single pole
☐ 1551.3102*



double pole
☐ 1552.3102*



double pole
☐ 1552.3602*
☐ 1552.2602
☐ 1552.4602*



double pole
☐ 1552.4606*

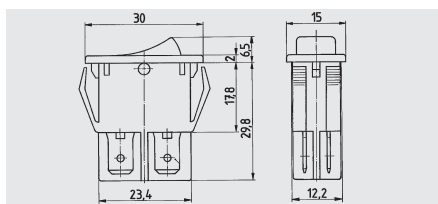

☐ quick-connect terminal 6,3

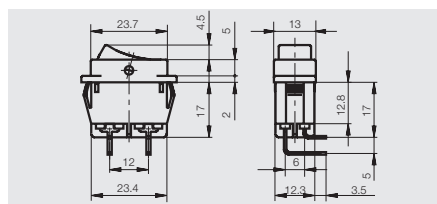

☐ angled PC-terminal

SWITCHES WITH MOMENTARY FUNCTION

16 (4) A 250 V~
10 (4) A 250 V~ 5E4
5/100A 250 V~
16 A 125 - 250 V AC
1 HP 125 V AC
2 HP 250 V AC



single pole NO
☐ 1551.3202*

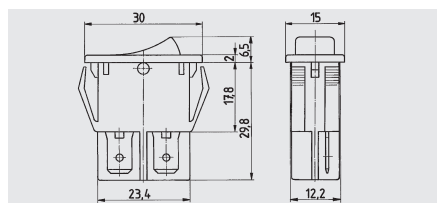

☐ quick-connect terminal 6.3

SERIES 5000 - SINGLE POLE PUSH BUTTON SWITCHES

UP TO 4(2) A 250 V~



PRODUCT ADVANTAGES

- ◆ Switching system with long life endurance, proven a million times
- ◆ With dust and splash water proofing according to IP 54
- ◆ Simple snap-on assembly for appliance panel thickness of 0.80 ... 5.00 mm

SWITCHING FUNCTIONS

- ◆ Switch with momentary function (NO)

TERMINAL VERSIONS

- ◆ Quick-connect terminal 2.8 mm

VERSIONS ON REQUEST

- ◆ Different colours of actuating caps

Electrical rating	4 (2) A 250 V~ 5E4 4 A 125 V AC 1/10 HP 2 A 250 V AC 1/10 HP	
Mechanical life endurance	2E5	
Resistance to tracking	PTI 250	
Contact gap	≥ 3 mm	
Insulation spacing	≥ 8 mm	
Protection type	IP 40 / IP 54	
Ambient temperature	terminal side	-20 °C ... +85 °C no condensation
	actuating side	-20 °C ... +55 °C no condensation
Storage temperature	-40 ... +80 °C	
Flammability	UL 94 V-2	
Heat and fire-resistance	850 °C (category D)	
Material push button and housing	PA	
Contacts	AgCu	
Terminals	silver-plated	
Temperature rise at the terminals (according to electrical life endurance)	max. 30 K (UL 1054) max. 55 K (EN 61058-1)	
Push-on force of connectors	≤ 64 N	
Approval marks		
Suitable for appliances of protection class II		

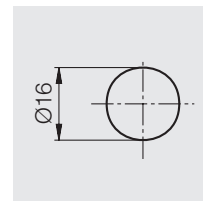

Appliance cut-out

The test conditions comply with EN 61058-1 and UL 1054



5000.0101



5000.0501
with dust and
water protection

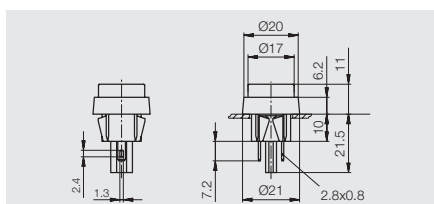

quick-connect terminal 2.8

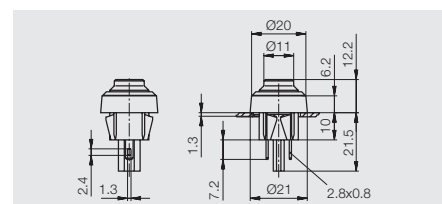

quick-connect terminal 2.8

SERIES 1840 - SINGLE POLE PUSH BUTTON SWITCHES

UP TO 6 (4) A 250V~



PRODUCT ADVANTAGES

- ◆ Switching principle with long life endurance due to a low friction contact system (ball), proven a 100 million times
- ◆ Excellent actuation characteristic (tactile feel)
- ◆ Simple assembly due to round appliance cut-out and screw fastening
- ◆ Staked terminals for reliable plugging of connectors
- ◆ Button for snapping on customized actuating caps

SWITCHING FUNCTIONS

- ◆ ST-switch
- ◆ DT-switch
- ◆ Switch with momentary function

TERMINAL VERSIONS

- ◆ Quick-connect terminal 4.8 mm
- ◆ Solder terminal

VERSIONS ON REQUEST

- ◆ Double pole switches
- ◆ Other terminal versions

ACCESSORIES

- ◆ Protective screw-on against dust and splash water
- ◆ Different push buttons

Electrical rating	6 (4) A 250 V~ 5E4 6 A 125 - 250 V AC 1/4 HP 125 V AC 1/2 HP 250 V AC
Mechanical life endurance	1E5
Contact resistance (new state)	< 100 mΩ (12 V, 1A DC)
Insulation resistance (new state)	> 100 MΩ (500 V DC between the open contacts)
High voltage resistance (new state)	1250 V eff. (between the open contacts) 3750 V eff. (reinforced insulation)
Resistance to tracking	PTI 250
Contact gap	≥ 3 mm
Insulation spacing	≥ 8 mm
Protection type	IP 40
Ambient temperature	terminal side -20 °C ... +100 °C no condensation actuating side -20 °C ... + 55 °C no condensation
Storage temperature	-40 ... +80 °C
Actuating force	6-9 N (depending on the switching function)
Flammability	UL 94 V-2
Heat and fire-resistance	850 °C (category D)
Material housing and push button	PA
Contacts	Ag
Terminals	silver-plated
Temperature rise at the terminals (according to electrical life endurance)	max. 30 K (UL 1054) max. 55 K (EN 61058-1)
Solderability of terminals	max. 350 °C, 3 sec. (no pressure on the terminals when soldering by hand!)
Push-on force of connectors	≤ 80 N
Approval marks	
Suitable for appliances of protection class II	

The test conditions comply with EN 61058-1 and UL 1054

SERIES 1840 - SINGLE POLE PUSH BUTTON SWITCHES

UP TO 6 (4) A 250V~

STANDARD VERSION/APPLIANCE CUT-OUT

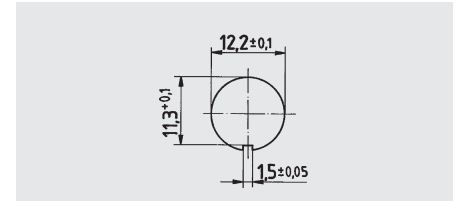

SINGLE POLE ST-SWITCHES

6 (4) A 250 V~ 5E4
 T 100/55
 6 A (1/4 HP) 125 V AC
 6 A (1/2 HP) 250 V AC

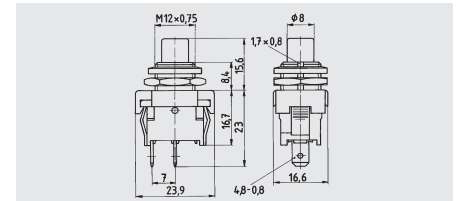

☐ 4.8 1841.1101*
 ☐ 1841.0101*

☐ quick-connect terminal 4.8

SINGLE POLE DT-SWITCHES

6 (4) A 250 V~ 5E4
 T 100/55
 6 A (1/4 HP) 125 V AC
 6 A (1/2 HP) 250 V AC

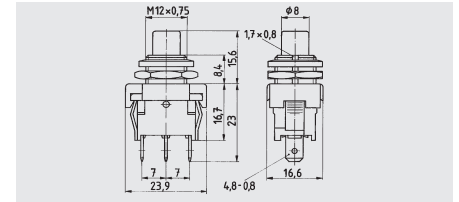

☐ 4.8 1843.1101*

☐ quick-connect terminal 4.8

SINGLE POLE WITH MOMENTARY FUNCTION

6 (2) A 250 V~
 T 100/55
 6 A (1/8 HP) 125-250 V AC



normally closed
 ☐ 4.8 1841.1301*

normally open
 ☐ 4.8 1841.1201*

DT momentary
 ☐ 4.8 1843.1201*

SINGLE POLE ST-SWITCHES

for snap-on push buttons

6 (4) A 250 V~ 5E4
 T 100/55
 6 A (1/4 HP) 125 V AC
 6 A (1/2 HP) 250 V AC

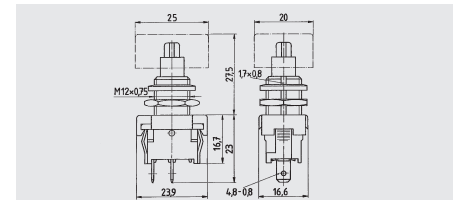

☐ 4.8 1841.6101*

☐ quick-connect terminal 4.8

Please order push buttons separately.

Additional versions on request

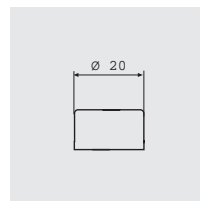

205 008 011

* Version on stock

SERIES 1683 - POWERFUL SINGLE POLE AND DOUBLE POLE

PUSH BUTTON SWITCHES UP TO 12 (8) A 250 V~

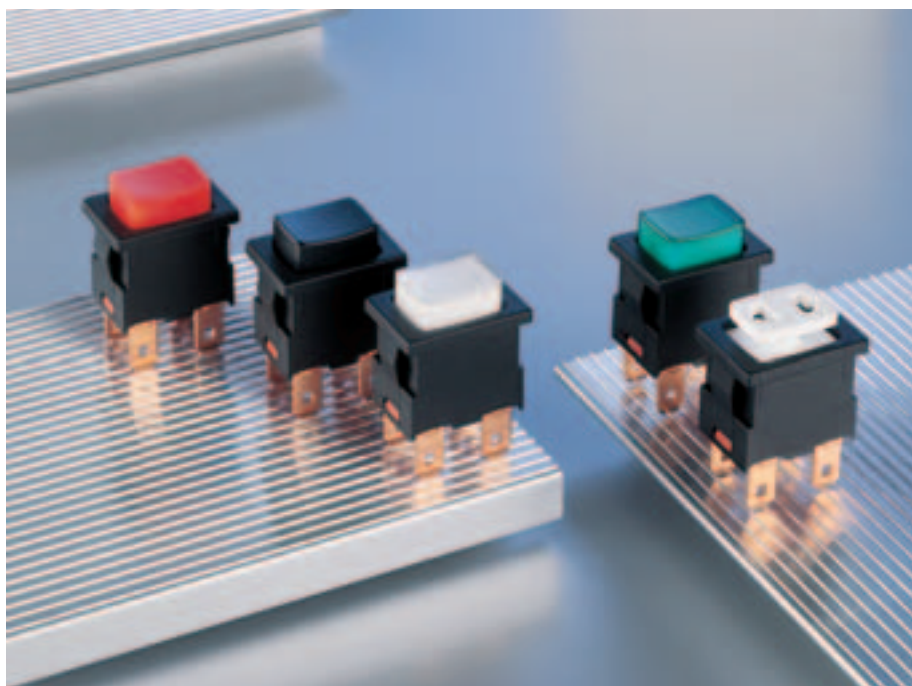

PRODUCT ADVANTAGES

- ◆ Double lifting contact system proven a million times
- ◆ High rating up to 12 (8) A 250 V~
- ◆ Small size for single and double pole versions
- ◆ Functionally reliable switching system up to 5E5 switching cycles (mechanically) due to two-sided switching core
- ◆ High electrical reliability due to separate spark chambers. Approved for high actuating speed according to EN 61058 (paragraph 17.2.6)

SWITCHING FUNCTIONS

- ◆ ST-switch
- ◆ ST-momentary function

TERMINAL VERSIONS

- ◆ Quick-connect-/solder-combination 4.8 mm vertical
- ◆ Quick-connect-/solder-combination 4.8 mm horizontal
- ◆ PC-terminal vertical
- ◆ PC-terminal horizontal

VERSIONS ON REQUEST

- ◆ Different colours of actuating caps
- ◆ Design adapter for snapping on customized caps
- ◆ ST-momentary function

Standard version and appliance cut-out

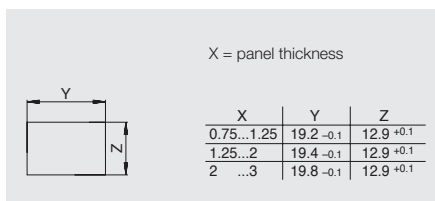
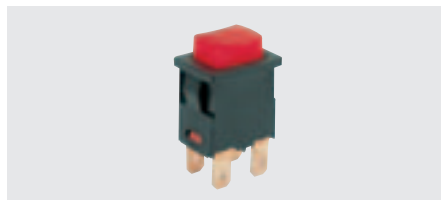

SERIES 1683 - POWERFUL SINGLE POLE AND DOUBLE POLE

PUSH BUTTON SWITCHES UP TO 12 (8) A 250 V~

Electrical rating	12 (8) A 250 V~ 10 (8) A 250 V~ 5E4 12 A 125 - 250 V AC 1/2 HP 125 - 250 V AC
Mechanical life endurance	≥ 1E5
Contact resistance (new state)	< 100 mΩ (12 V, 1A DC)
Insulation resistance (new state)	> 100 MΩ (500 V DC between the open contacts)
High voltage resistance (new state)	1250 V eff. (between the open contacts) 3750 V eff. (reinforced insulation)
Resistance to tracking	PTI 250
Contact gap	≥ 3 mm
Insulation spacing	≥ 8 mm
Protection type	IP 40
Ambient temperature	terminal side: -20 °C ... +100 °C no condensation actuating side: -20 °C ... + 55 °C no condensation
Storage temperature	-40 ... +80 °C
Actuating force	single pole non-illuminated: ca. 8 N single pole illuminated and double pole: ca. 12 N
Flammability	UL 94 V-2
Heat and fire-resistance	850 °C (categoryD)
Material	socket and housing: PA push button: PC
Contacts	Ag
Terminals	Cu resp. silver-plated
Temperature rise at the terminals (according to electrical life endurance)	max. 30 K (UL 1054) max. 55 K (EN 61058-1)
Solderability of terminals	max. 350 °C, 3 sec. (no pressure on the terminals when soldering by hand!)
Push-on force of connectors	≤ 80 N
Approval marks	
Suitable for appliances of protection class II	

The test conditions comply with EN 61058-1 and UL 1054

ST-SWITCHES

with indicator lamp

12 (8) A 250 V~
10 (8) A 250 V~ 5E4
T 100/55
12 A (1/2 HP) 125-250 V AC



single pole
□ 1686.1101*



double pole
□ 1687.1104*

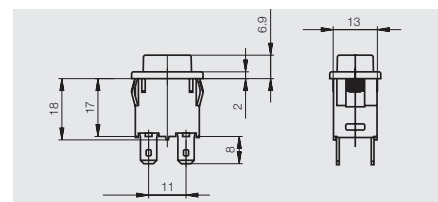

□ quick-connect terminal 4.8

ST-SWITCHES

12 (8) A 250 V~
10 (8) A 250 V~ 5E4
T 100/55
12 A (1/2 HP) 125-250 V AC



single pole
□ 1683.1101*



double pole
□ 1684.1101*

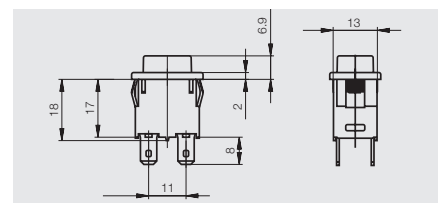

□ quick-connect terminal 4.8

* Version on stock

SERIES 1680 - POWERFUL SINGLE POLE AND DOUBLE POLE

PUSH BUTTON SWITCHES UP TO 12 (8) A 250 V~



Standard version



PRODUCT ADVANTAGES

- ◆ Contact system with bridging contacts, proven a million times
- ◆ High electrical rating
- ◆ High mechanical load capacity up to 750 N (installation-dependent), e.g. for foot switches
- ◆ Optimum button guide
- ◆ Functionally reliable switching system up to 15E4 cycles (mechanical) due to two-sided switching core
- ◆ Small size for single pole and double pole versions
- ◆ For direct and indirect actuation
- ◆ Safe solder connections due to double PCB pins
- ◆ Variable actuator lengths
- ◆ Safe fitting of the actuating caps due to longer guide

SWITCHING FUNCTIONS

- ◆ ST-switch
- ◆ DT-switch (Normally open)

TERMINAL VERSIONS

- ◆ Quick-connect-/solder-combination 4.8 mm vertical
- ◆ Quick-connect-/solder-combination 4.8 mm horizontal
- ◆ PC-terminal vertical
- ◆ PC-terminal horizontal

VERSIONS ON REQUEST

- ◆ PCB versions with additional lugs for relieving the strain on the PCB solder points
- ◆ DT-switches (Normally open)

ACCESSORIES

- ◆ Customized actuating caps on request

SERIES 1680 - POWERFUL SINGLE POLE AND DOUBLE POLE

PUSH BUTTON SWITCHES UP TO 12 (8) A 250 V~

Electrical rating	12 (8) A 250 V~ 10 (8) A 250 V~ 5E4 12 A 125 - 250 V AC 1/2 HP 125 - 250 V AC	
Mechanical life endurance	≥ 15E4	
Contact resistance (new state)	< 100 mΩ (12 V, 1A DC)	
Insulation resistance (new state)	> 100 MΩ (500 V DC between the open contacts)	
High voltage resistance (new state)	1250 V eff. (between the open contacts) 3750 V eff. (reinforced insulation)	
Resistance to tracking	PTI 250	
Contact gap	≥ 3 mm	
Insulation spacing	≥ 8 mm	
Protection type	IP 40	
Ambient temperature	terminal side	-20 °C ... +100 °C no condensation
	actuating side	-20 °C ... + 55 °C no condensation
Storage temperature	-40 ... +80 °C	
Actuating force	single pole	ca. 7 N
Actuating force	double pole	ca. 9 N
Flammability	push button	UL 94 V-0
	socket	UL 94 V-1
	housing	UL 94 V-2
Heat and fire-resistance	850 °C (category D)	
Material	push button	PBTP
	socket	PA
	housing	PA
Contacts	Ag	
Terminals	Cu resp. silver-plated	
Temperature rise at the terminals (according to electrical life endurance)	max. 30 K (UL 1054) max. 55 K (EN 61058-1)	
Solderability of terminals	max. 350 °C, 3 sec. (no pressure on the terminals when soldering by hand!)	
Push-on force of connectors	≤ 80 N	
Approval marks		
Suitable for appliances of protection class II		

The test conditions comply with EN 61058-1 and UL 1054

SINGLE POLE ST-SWITCHES

for snapping on customized actuating caps

12 (8) A 250 V~
10 (8) A 250 V~ 5E4
T 100/55
12 A (1/2 HP) 125 - 250 V AC

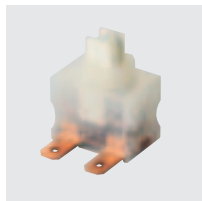

1681.3701*

Switching position	h
OFF	24,0
ON	21,3
Block	19,7

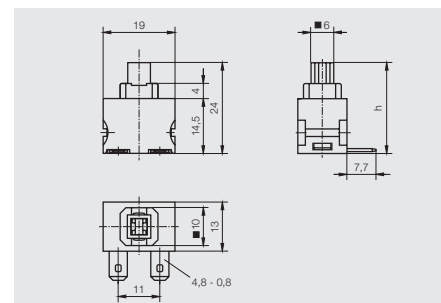

SERIES 1680 - POWERFUL SINGLE POLE AND DOUBLE POLE

PUSH BUTTON SWITCHES UP TO 12 (8) A 250 V~

SINGLE POLE ST-SWITCHES

12 (8) A 250 V~
 10 (8) A 250 V~ 5E4
 T 100/55
 12 A (1/2 HP) 125 - 250 V AC



1681.1101*

Switching position	h
OFF	26,5
ON	23,8
Block	22,2

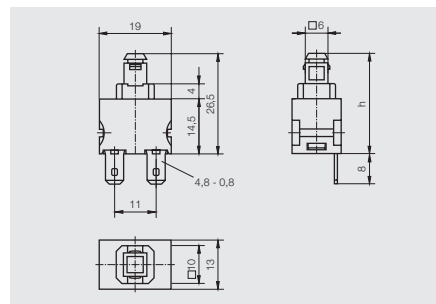

1681.3101*

Switching position	h
OFF	26,5
ON	23,8
Block	22,2

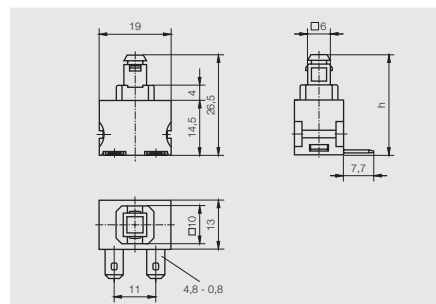

SINGLE POLE ST-SWITCHES

with short actuator

12 (8) A 250 V~
 10 (8) A 250 V~ 5E4
 T 100/55
 12 A (1/2 HP) 125 - 250 V AC

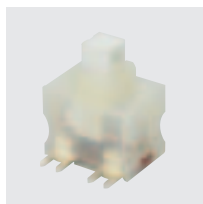

1681.4402*

Switching position	h
OFF	24,0
ON	21,3
Block	19,7

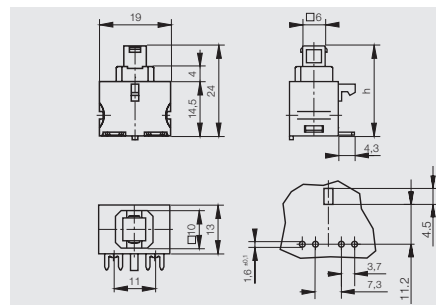

DOUBLE POLE ST-SWITCHES

12 (8) A 250 V~
 10 (8) A 250 V~ 5E4
 T 100/55
 12 A (1/2 HP) 125 - 250 V AC



1682.1101*

Switching position	h
OFF	26,5
ON	23,8
Block	22,2

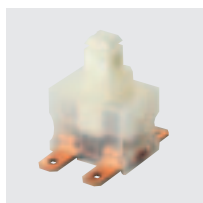
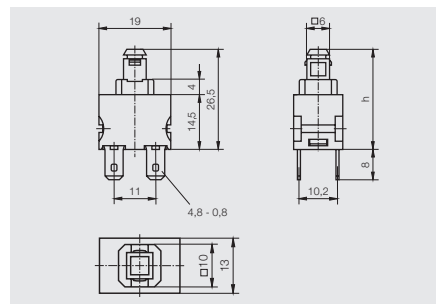

1682.3101*

Switching position	h
OFF	26,5
ON	23,8
Block	22,2

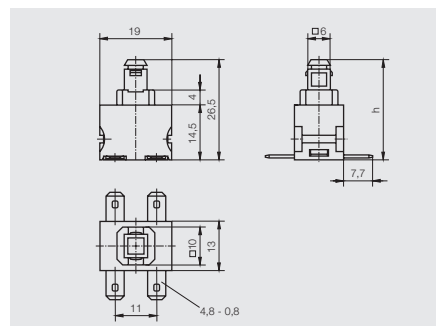

SERIES 1660 / 1670 - POWERFUL SINGLE POLE AND DOUBLE POLE

PUSH BUTTON SWITCHES UP TO 16 (4) A 250 V~



PRODUCT ADVANTAGES

- ◆ The switches of the 1670 series contain an integrated gasket between the actuator and the switch housing.
- ◆ Switching system (snap-action contact), proven a million times
- ◆ High ratings up to 16(4)A 250V~
- ◆ Opening and closing speed independent of the actuating speed
- ◆ Contact system with bridging contacts
- ◆ Push button switches with a silk matt surface and an abrasionproof marking
- ◆ Versions with indicator lamp also available with separate lamp connection (switch with integrated signal lamp)
- ◆ Single pole and double pole switches in the same size
- ◆ Simple snap-on assembly
- ◆ Tight fit in appliance cut-out due to tolerance compensation ribs on the switch housing



SWITCHING FUNCTIONS

- ◆ ST-switch, switch with momentary function (NC and NO)
- ◆ ST-switch with indicator lamp
- ◆ DT-switch/DT-switch with momentary function
- ◆ ST-switch, switch with momentary function (NC and NO) with separate lamp connection
- ◆ Pilot light

TERMINAL VERSIONS

- ◆ Quick-connect terminal 6.3
- ◆ Quick-connect terminal 4.8
- ◆ Quick-connect terminal 6.3 with 2 x 4.8 for separate lamp connection

VERSIONS ON REQUEST

- ◆ With  and -approval marks
- ◆ For customized push buttons

SERIES 1660 / 1670 - POWERFUL SINGLE POLE AND DOUBLE POLE

PUSH BUTTON SWITCHES UP TO 16 (4) A 250 V~

STANDARD VERSION SERIES 1660

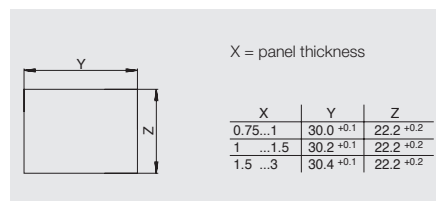

STANDARD VERSION SERIES 1670

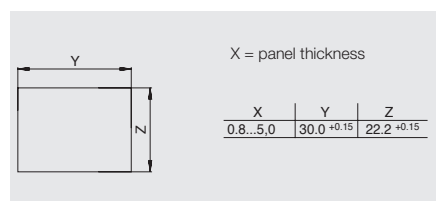

Electrical rating	16 (4) A 250 V~	
Mechanical life endurance	5E4	
Contact resistance (new state)	< 100 mΩ (12 V, 1A DC)	
Insulation resistance (new state)	> 100 MΩ 500 V DC (between the open contacts)	
High voltage resistance (new state)	1250 V eff. (between the open contacts) 3750 V eff. (reinforced insulation)	
Resistance to tracking	PTI 250	
Contact gap	≥ 3 mm	
Insulation spacing	≥ 8 mm	
Protection type series 1660	IP 40	
Protection type series 1670	IP 54	
Ambient temperature	terminal side	-20 °C ... +85 °C no condensation
	actuating side	-20 °C ... +55 °C no condensation
Storage temperature	-40 ... +80 °C	
Actuating force	ca. 8 N	
Flammability	UL 94 V-2	
Heat and fire-resistance	850 °C (category D)	
Material	housing and push button	PA
	push button illuminated	PC
Contacts	Ag	
Terminals	Cu	
Temperature rise at the terminals (according to electrical life endurance)	max. 30 K (UL 1054) max. 55 K (EN 61058-1)	
Push-on force of connectors	≤ 80 N	
Approval marks	Series 1660 additionally	
Suitable for appliances of protection class II		

The test conditions comply with EN 61058-1 and UL 1054



SERIES 1660 - POWERFUL SINGLE POLE AND DOUBLE POLE

PUSH BUTTON SWITCHES UP TO 16 (4) A 250 V~

DOUBLE POLE ST-SWITCHES

with indicator lamp

16 (4) A 250 V~

Switches for 125 V AC or 250 V AC with  and -approval marks and single pole versions on request.

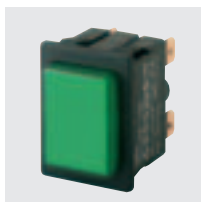

 1660.0202*



 1660.0201*

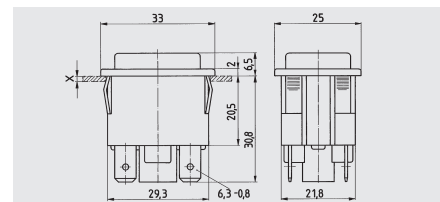



 quick-connect terminal 6.3

DOUBLE POLE ST-SWITCHES

with indicator lamp and separate lamp connection. The indicator lamp is independent of the switching system.

16 (4) A 250 V~

Switches for 125 V AC or 250 V AC with  and -approval marks and single pole versions on request.

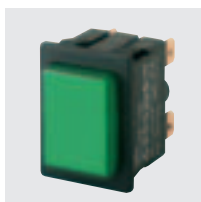

 1660.3202

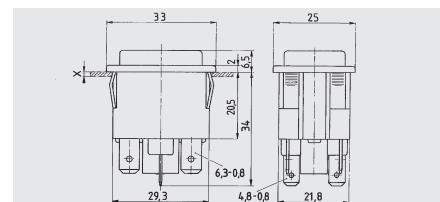

 quick-connect terminal 6.3 with 2 x 4.8 for separate lamp connection

ST-SWITCHES

16 (4) A 250 V~

Switches for 125 V AC or 250 V AC with  and -approval marks on request



single pole
 1662.0201



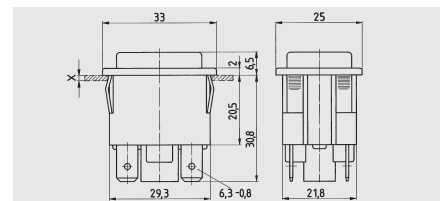

double pole
 1661.0201*



 quick-connect terminal 6.3

NORMALLY OPEN-SWITCHES

16 (4) A 250 V~

Switches for 125 V AC or 250 V AC with  and -approval marks on request



single pole
 1662.0101*



double pole
 1661.0101*

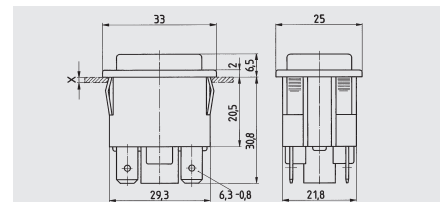

 quick-connect terminal 6.3

DT-SWITCHES WITH MOMENTARY FUNCTION

12 (4) A 250 V~ μ

DT-switches on request



single pole
 1664.0101



double pole
 1663.0101

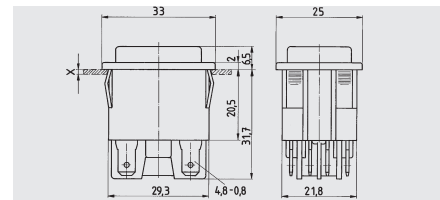

 quick-connect terminal 4.8



* Version on stock

SERIES 1660 - POWERFUL SINGLE POLE AND DOUBLE POLE

PUSH BUTTON SWITCHES UP TO 16 (4) A 250 V~

DOUBLE POLE ST-SWITCHES

with dust and water proofing according to IP 54

Switches with - and -approval marks on request.



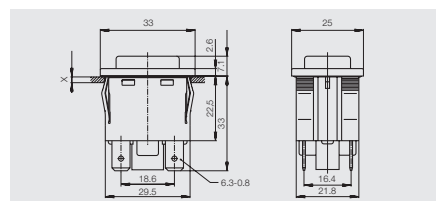

double pole
☐ 1671.5201*



☐ quick-connect terminal 6.3

DOUBLE POLE ST-SWITCHES

with indicator lamp and dust and water proofing according to IP 54

Switches with - and -approval marks on request.



double pole
☐ 1670.5202*

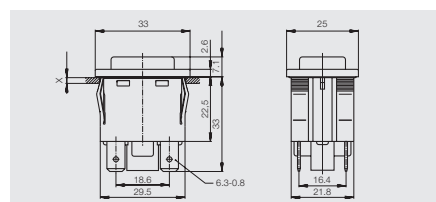

☐ quick-connect terminal 6.3

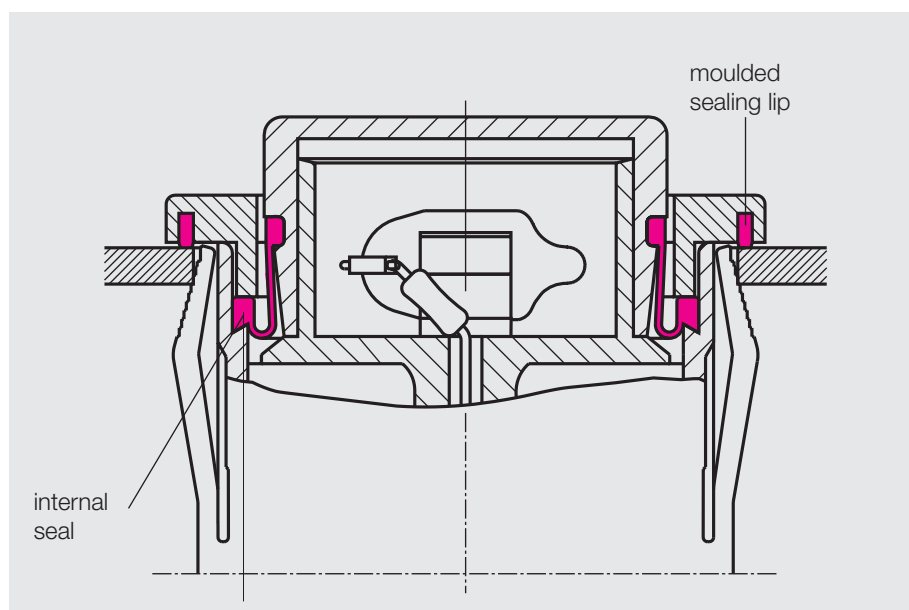

PILOT LIGHTS 1660

Pilot light with neon lamp and resistor for 230 V~, protection type IP 40



Pilot light for 125 V AC on request



☐ 1667.0101



☐ 1667.0102*

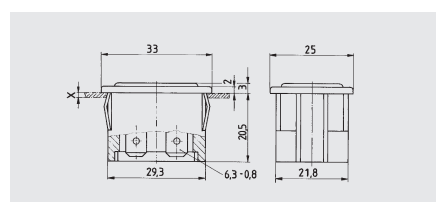

☐ quick-connect terminal 6.3

SERIES 4021 - DOUBLE POLE SLIDE SWITCHES FOR 2 (0,5)A 250V~ AND 5 A 250 V~ RESP. 10 A 125 V~ FOR CURRENTLESS SWITCHING



PRODUCT ADVANTAGES

- ◆ Suited as voltage selectors (for currentless switching!)
- ◆ Slide sunken to protect against accidental actuation
- ◆ Simple assembly with screws

SWITCHING FUNCTIONS



- ◆ DT-switch

TERMINAL VERSIONS

- ◆ Quick-connect terminal 2.8 mm
- ◆ Solder terminal
- ◆ Straight PC-terminal
- ◆ Angled PC-terminal

VERSIONS ON REQUEST

- ◆ With tinned and sealed PC-terminals (for flow soldering)
- ◆ Single pole versions in the same size
- ◆ Four pole switches
- ◆ With lateral PC-terminals

Electrical rating	2 (0,5) A 250 V~
Electrical rating for currentless switching	5 A 250 V~ 10 A 125 V~
Mechanical life endurance	1E4
Contact resistance (new state)	< 100 mΩ (12 V, 1A DC)
Insulation resistance (new state)	> 100 MΩ (500 V DC between the open contacts)
High voltage resistance (new state)	1250 V eff. (between the open contacts) 3750 V eff. (reinforced insulation)
Resistance to tracking	PTI 250
Contact gap	≥ 3 mm
Insulation spacing	≥ 8 mm
Protection type	IP 40
Ambient temperature	terminal side actuating side
	-20 °C ... +85 °C no condensation -20 °C ... +55 °C no condensation
Storage temperature	-40 °C ... +80 °C
Flammability push button and housing	UL 94 V-2
Heat and fire-resistance	850 °C (category D)
Material push button and housing	PA
Contacts	CuAg
Terminals	silver-plated
Temperature rise at the terminals (according to electrical life endurance)	max. 30 K (UL 1054) max. 55 K (EN 61058-1)
Push-on force of connectors	≤ 60 N
Approval marks	 
Suitable for appliances of protection class II	

The test conditions comply with EN 61058-1 and UL 1054

SERIES 4021 - DOUBLE POLE SLIDE SWITCHES FOR 2(0,5)A 250V~ AND 5 A 250 V~ RESP. 10 A 125 V~ FOR CURRENTLESS SWITCHING

DOUBLE POLE DT-SWITCHES



☐ 4021.0801
☐ 4021.0101*

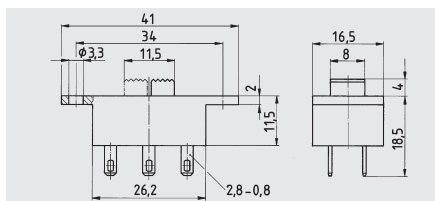

☐ quick-connect terminal 2.8

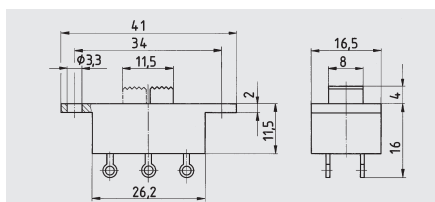

☐ solder terminal



☐ 4021.1811
☐ 4021.4420*

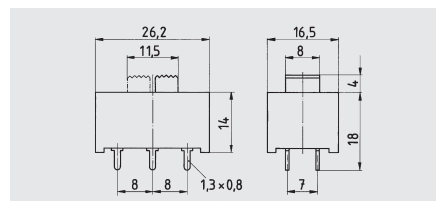

☐ PC terminal

DOUBLE POLE DT-SWITCHES

with marking 230 V / 115 V



☐ 4021.0512*
☐ 4021.0203

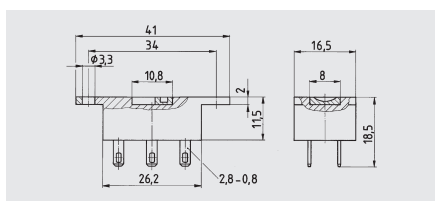

☐ quick-connect terminal 2,8

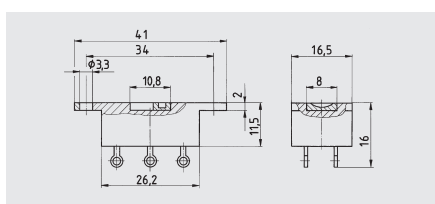

☐ solder terminal



☐ 4021.4620*
☐ 4021.4723*

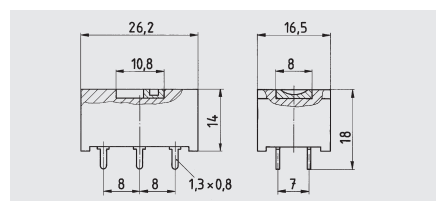

☐ PC-terminal

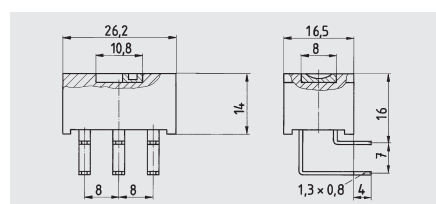

☐ angled PC-terminal

SERIES 1703 - POWERFUL ROTARY SWITCHES

UP TO 20 (4) A 400 V~



PRODUCT ADVANTAGES

- ◆ Powerful rotary switches up to 20(4)A 400V~, for example in ovens, flow heaters or as selector switches for speed controls and temperature adjustments
- ◆ 60° switching angle
- ◆ Creep path and air gap ≥ 8 mm, therefore suitable for mains and touchable low voltages
- ◆ Forced contact opening
- ◆ Fixed with M12 thread or bayonet catch (both with integrated anti-twist)

SWITCHING FUNCTIONS

- ◆ ST-switch

TERMINAL VERSIONS

- ◆ Quick-connect terminal 6.3

VERSIONS ON REQUEST

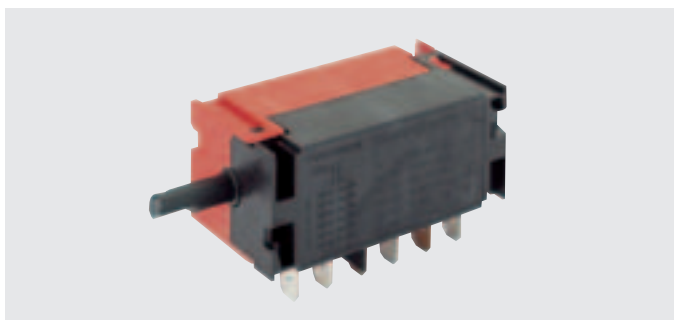

- ◆ Single pole up to four pole switches
- ◆ With PC-terminals
- ◆ With soldered stranded wires
- ◆ With additional switching sequences
- ◆ For higher electrical ratings
- ◆ With gold-plated contacts

Customized version



SERIES 1703 - POWERFUL ROTARY SWITCHES

UP TO 20 (4) A 400 V~

Electrical rating	20 (4) A 400 V~ 16 A 12 V DC 8 A 24 V DC
Mechanical life endurance	3E4
Contact resistance (new state)	< 100 mΩ (12 V, 1A DC)
Insulation resistance (new state)	> 100 MΩ (500 V DC between the open contacts)
High voltage resistance (new state)	1250 V eff. (between the open contacts) 3750 V eff. (reinforced insulation)
Resistance to tracking	PTI 400
Contact gap	≥ 3 mm
Insulation spacing	≥ 8 mm
Protection type	IP 40
Ambient temperature	-20 °C ... +100 °C no condensation
Storage temperature	-40 °C ... +80 °C
Flammability	Housing UL 94 V-0 Shaft UL 94 V-2
Heat and fire-resistance	850 °C (category D)
Material housing and shaft	PA
Contacts	Ag
Terminals	CuZn resp. silver-plated
Temperature rise at the terminals (according to electrical life endurance)	max. 55 K (EN 61058-1)
Push-on force of connectors	≤ 80 N
Approval marks	 or 
Suitable for appliances of protection class II	

The test conditions comply with EN 61058-1

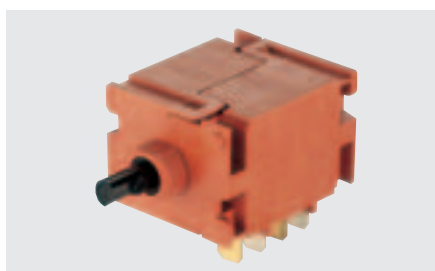

double pole / switching position 0-I

 1703.3201

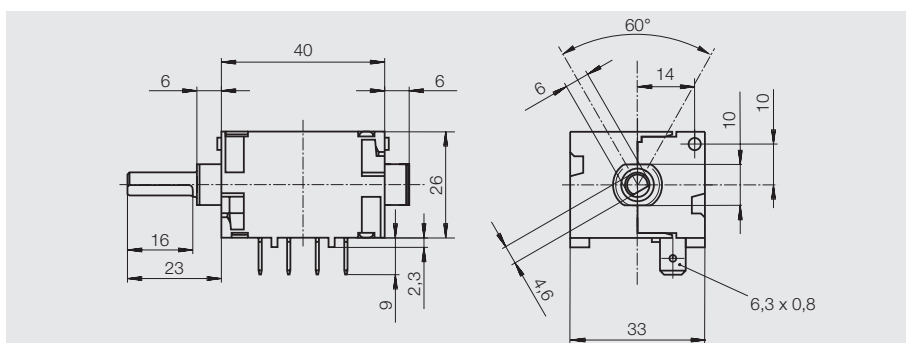

 quick-connect terminal 6.3

SERIES 1810 / 1820 - SINGLE POLE AND DOUBLE POLE TOGGLE

SWITCHES UP TO 10(4)A 250V~



PRODUCT ADVANTAGES

- ◆ Switching principle with long life endurance due to a low friction contact system (ball), proven a 100 million times
- ◆ Excellent actuation characteristic
- ◆ Simple assembly of the series 1820 due to round appliance cut-out and screw fastening
- ◆ Staked terminals for reliable plugging of connectors

SWITCHING FUNCTIONS

- ◆ ST-switch
- ◆ DT-switch
- ◆ DT-switch with centre-OFF

TERMINAL VERSIONS

- ◆ Quick-connect terminal 4.8
- ◆ Solder terminal
- ◆ Straight PC-terminal

ACCESSORIES

- ◆ Protection caps against dust and splash water (see page **2.48**)
- ◆ Tubular push-on covers for colour coding of the individual switches (see page **2.48**)

SERIES 1810 / 1820 - SINGLE POLE AND DOUBLE POLE TOGGLE

SWITCHES UP TO 10 (4) A 250 V~

STANDARD VERSION 1810

single pole and double pole



single pole

X = panel thickness

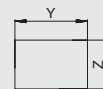

X	Y	Z
0.75...1.25	19.2 ^{-0.1}	12.9 ^{+0.1}
1.25...2	19.4 ^{-0.1}	12.9 ^{+0.1}
2 ...3	19.8 ^{-0.1}	12.9 ^{+0.1}

double pole

X = panel thickness

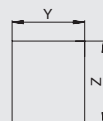



X	Y	Z
0.75...1.25	19.2 ^{-0.1}	21.9 ^{+0.1}
1.25...2	19.4 ^{-0.1}	21.9 ^{+0.1}
2 ...3	19.8 ^{-0.1}	21.9 ^{+0.1}

STANDARD VERSION 1820

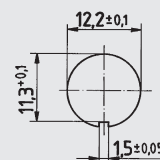
single pole and double pole



Electrical rating		10 (4) A 250 V~ 6 (4) A 250 V~ 5E4 6 A 125 - 250 V AC 1/4 HP 125 V AC 1/2 HP 250 V AC
Mechanical life endurance	ST/DT	1E5
	DT with centre-OFF	5E4
Contact resistance (new state)		< 100 mΩ (12 V, 1A DC)
Insulation resistance (new state)		> 100 MΩ (500 V DC between the open contacts)
High voltage resistance (new state)	< 3 mm ≥ 3 mm	750 V eff. (between the open contacts) 1250 V eff. (reinforced insulation) 3750 V eff. (reinforced insulation)
Resistance to tracking		PTI 250
Contact gap		≥ 3 mm
Insulation spacing		≥ 8 mm
Protection type		IP 40
Ambient temperature	terminal side actuating side	-20 °C ... +100 °C no condensation -20 °C ... + 55 °C no condensation
Storage temperature		-40 °C ... +80 °C
Flammability toggle and housing		UL 94 V-2
Heat and fire-resistance		850 °C (category D)
Material toggle and housing		PA
Contacts		Ag
Terminals		silver-plated
Temperature rise at the terminals (according to electrical life endurance)		max. 30 K (UL 1054) max. 55 K (EN 61058-1)
Push-on force of connectors		≤ 80 N
Approval marks		  
Suitable for appliances of protection class II		

The test conditions comply with EN 61058-1 and UL 1054

ST-SWITCHES SERIES 1820

6 (4) A 250 V~ 5E4
 T 100/55
 6 A (1/4 HP) 125 V AC
 6 A (1/2 HP) 250 V AC



single pole
 □ 1821.1101*
 □ 1821.0101*

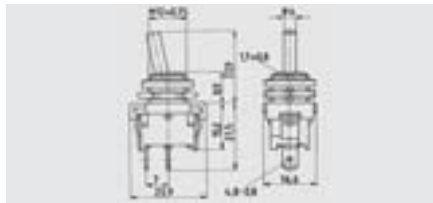

□ quick-connect terminal 4.8



double pole
 □ 1822.1101*
 □ 1822.0101*

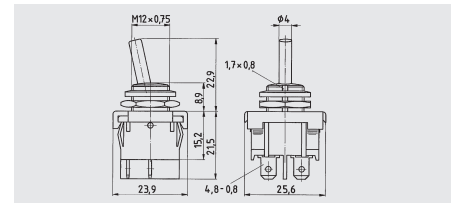

□ quick-connect terminal 4.8

ST-SWITCHES SERIES 1810

10 (4) A 250 V~
 6 (4) A 250 V~ 5E4
 T 100/55
 6 A (1/4 HP) 125 V AC
 6 A (1/2 HP) 250 V AC

Switches with and -approval marks for 10 A on request.



single pole
 □ 1811.1102*

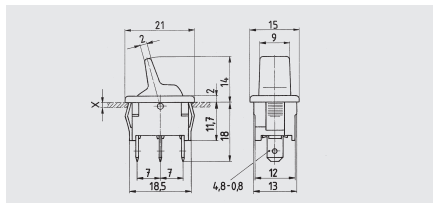

□ quick-connect terminal 4.8



double pole
 □ 1812.1102*

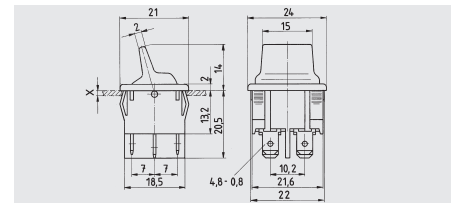

□ quick-connect terminal 4.8

DT-SWITCHES SERIES 1820

6 (4) A 250 V~ 5E4
 T 100/55



single pole
 □ 1823.1101*
 □ 1823.0101*

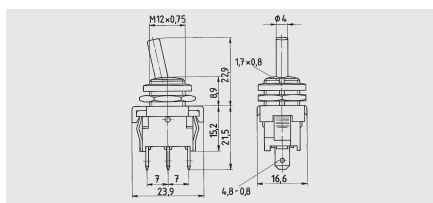

□ quick-connect terminal 4.8



double pole
 □ 1824.1101*
 □ 1824.0101

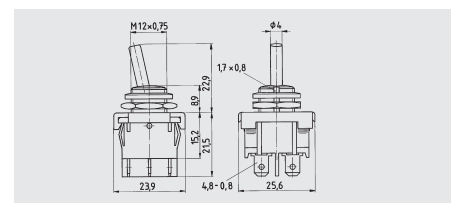

□ quick-connect terminal 4.8



* Version on stock

SERIES 1810 / 1820 - SINGLE POLE AND DOUBLE POLE TOGGLE

SWITCHES UP TO 10 (4) A 250 V~

DT-SWITCHES SERIES 1810

10 (4) A 250 V~
 6 (4) A 250 V~ 5E4
 T 100/55
 6 A (1/4 HP) 125 V AC
 6 A (1/2 HP) 250 V AC

Switches with  and -approval marks for 10 A on request.



single pole
 1813.1102*

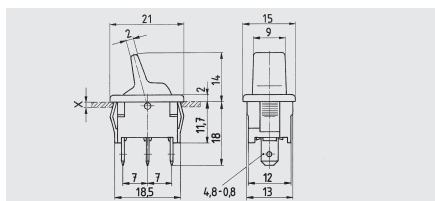

 quick-connect terminal 4.8



double pole
 1814.0102

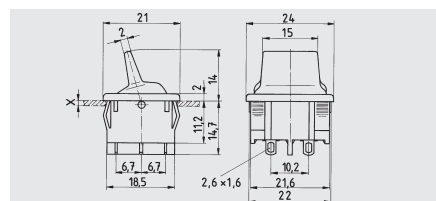

 solder terminal



DT-SWITCHES SERIES 1820

with centre-OFF



6 (2) A 250 V~ μ
 T 100/55

Momentary on one side function on request



single pole without momentary
 1828.1101*
 1828.0101* momentary on both sides
 1828.1301



double pole without momentary
 1829.1101
 1829.0101 momentary on both sides
 1829.1301

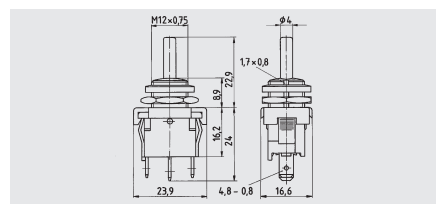

 quick-connect terminal 4.8

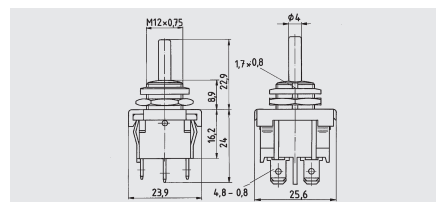

 quick-connect terminal 4.8



DT-SWITCHES SERIES 1810

with centre-OFF

6 (2) A 250 V~ μ
 T 100/55
 6 A (1/8 HP) 125-250 V AC

Momentary on one side on request



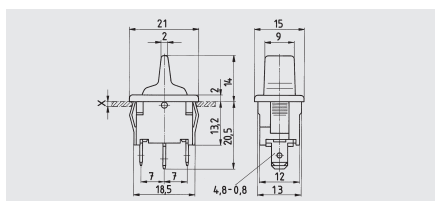

single pole without momentary
 1818.1102* momentary on both sides
 1818.1302*



 quick-connect terminal 4.8



double pole without momentary
 1819.1102 momentary on both sides
 1819.1302*

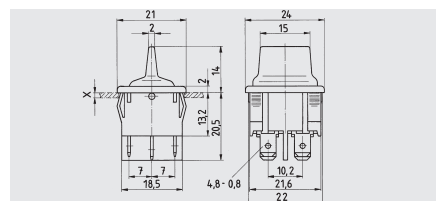

 quick-connect terminal 4.8

SERIES 2410 - FOOT SWITCHES UP TO 6 (2,5) A 250 V~



PRODUCT ADVANTAGES

- ◆ For ratings up to 6 (2,5) A 250 V~
- ◆ Ergonomical dimensions allow actuation without tiring
- ◆ Long life endurance
- ◆ Distinct actuation characteristic
- ◆ Retrofittable cable
- ◆ Retrofittable protection hood

TECHNICAL DATA

- ◆ Mechanical life endurance 3E5
- ◆ Resistance to tracking PTI 250
- ◆ Foot tread and housing made of PA
- ◆ Contacts Ag
- ◆ 

single pole
contact gap < 3 mm

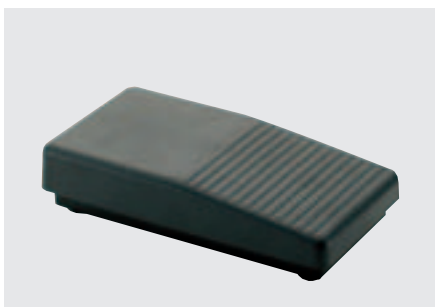

Normally open 2410.0301* DT momentary 2410.0401*

with terminal strip and strain relief clip in the housing

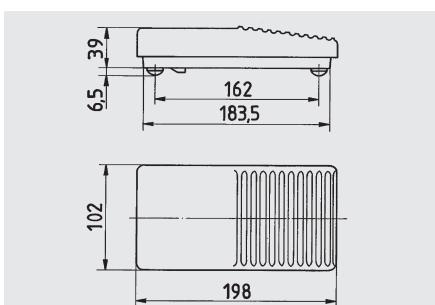

double pole
contact gap > 3 mm



Normally open 2410.1001

with three-core cable connection,
earthing-plug and -linkage
length: to mains supply 3000 mm
to appliance 250 mm

* Version on stock

ACCESSORIES FOR THE APPLIANCE SWITCHES

PROTECTION CAPS

When mounted in the appliance, the actuation side of the switch is dust-tight and protected against splash water.

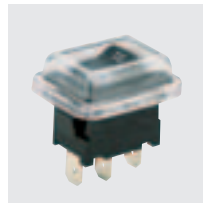

203 089 011*

suitable for the series

1800. 1855.
1801. 1858.
1803.
1808.

appliance cut-out single pole

X = panel thickness

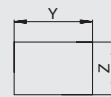

X	Y	Z
0.75...1.25	19.4 ^{-0.1}	12.9 ^{+0.1}
1.25...2.2	19.8 ^{-0.1}	12.9 ^{+0.1}

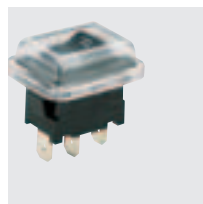

203 090 011*

suitable for the series

1802.
1804.
1805.
1809.

appliance cut-out double pole

X = panel thickness

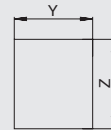

X	Y	Z
0.75...1.25	19.4 ^{-0.1}	21.9 ^{+0.1}
1.25...2.2	19.8 ^{-0.1}	21.9 ^{+0.1}



203 201 011*

suitable for the series

1832. 1661.
1834. 1662.
1835. 1663.
1839. 1664.
1665.
1667.

X = panel thickness

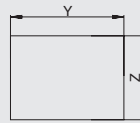

X	Y	Z
0.75...1.4	30.2 ^{-0.1}	22.0 ^{+0.2}
1.4...2.4	30.6 ^{-0.1}	22.0 ^{+0.2}

appliance cut-out with protection cap

TUBULAR PUSH-ON COVERS

These push-on covers are appropriate for a better marking of plastic levers especially of the series 1820.

Additional colours on request.



203 105 011*



203 105 031

PROTECTION CAP

This cap protects the installed switch against dust and splash water from the actuation side.



343 001 023*

SNAP ACTION SWITCHES

1



TECHNICAL INFORMATION

Pages **1.1 - 1.5**

2



APPLIANCE SWITCHES

Pages **2.1- 2.48**

3



SNAP ACTION SWITCHES

Pages **3.1 - 3.33**

4

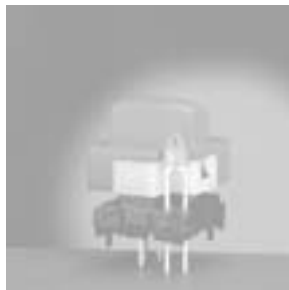

KEYMODULES

Pages **4.1 - 4.9**

5

INDEX OF PART NUMBERS

Pages **5.1 - 5.3**

CONTENTS SNAP ACTION SWITCHES

For an index of all versions on stock and their packaging units see pages **5.2** and **5.3**.

TECHNICAL INFORMATION

SNAP ACTION SWITCHES

Pages
3.4 - 3.5

ENCLOSED SNAP ACTION SWITCHES



SERIES 1056

change-over
up to 4 A 12 V resp. 2 A 24 V
protection type IP 40

Pages
3.6 - 3.9



SERIES 1055

change-over
up to 4 A 12 V resp. 2 A 24 V,
dust and water proofing
according to IP 67

Pages
3.6 - 3.9

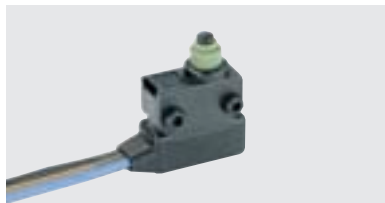

SERIES 1058

change-over, normally open and normally closed up to 4 A 12 V resp. 2 A 24 V,
dust and water proofing according to IP 67

Pages
3.6 - 3.9



SERIES 1050

change-over, normally open and normally closed up to 10 (1,5) A 250 V~
size DIN 41635 design B
protection type IP 40

Pages
3.10 - 3.13

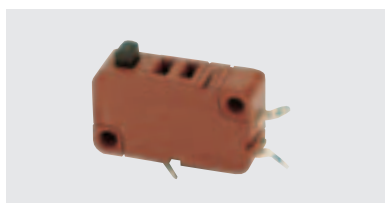

SERIES 1080 AND 1085

change-over, normally open and normally closed up to 21 (8) A 250 V~ 10E3
size DIN 41635 design A
protection type IP 40

Pages
3.14 - 3.16



SERIES 1004, 1005 AND 1006

change-over, normally open and normally closed up to 21 (8) A 250 V~ 25E3
size DIN 41635 design A
protection type IP 40

Pages
3.17 - 3.21

OPEN AND ENCLOSED
SNAP ACTION SWITCHES



SERIES 1019

normally open and normally closed
for 6 (2) A 250 V~
open and enclosed version
with or without lever

Pages
3.22 - 3.23

OPEN SNAP ACTION SWITCHES

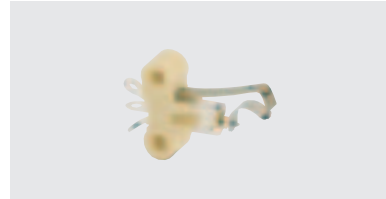

SERIES 1010

change-over, normally open and nor-
mally closed up to 10 (3) A 250 V~
size DIN 41635 design C

Pages
3.24 - 3.26

BI-STABLE
SNAP ACTION SWITCHES

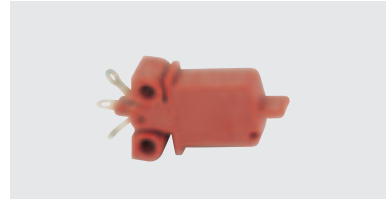

SERIES 1011

DT-switch
up to 6 (2) A 250 V~

Page
3.27

ENCLOSED
SNAP ACTION SWITCHES



SERIES 1022

change-over, normally open and nor-
mally closed up to 4 A 12 V resp.
2 A 24 V
dust and water proofing
according to IP 67

Pages
3.28 - 3.29



SERIES 1117

normally open and normally closed
for 16 (6) A 400 V~

Pages
3.30 - 3.31

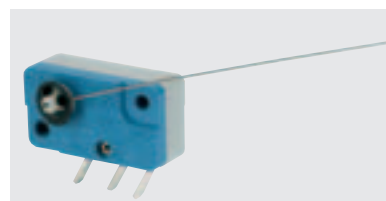

SERIES 1040

change-over and normally open
up to 4 (1) A 250 V~
with rotary shaft actuation

Page
3.32

OPEN LEAF SWITCHES

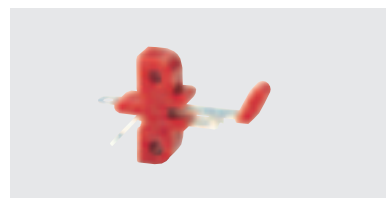

SERIES 1017

change-over and normally open
up to 100 mA 24 V

Page
3.33

ADDITIONAL TECHNICAL INFORMATION

CONTACT RESISTANCE

The contact resistance is the electrical resistance measured at the terminals of the switch when the contacts are closed. The resistance specifications refer to unwired switches in new condition. For silver-based contact materials this value is below 100 m Ω , in gold-based materials below 50 m Ω .

SWITCHING SECURITY

The highest switching security is obtained by utilizing from the entire pre-travel and over-travel. Another element is the contact force which depends in turn on the actuating force. Switches with high contact forces should be chosen if possible.

BOUNCE TIME

The bounce time is the time between the first closing of the contacts (turn-on signal) and the last dropping below a given threshold value of the contact resistance. The values are typically below 5 ms.

SWITCHING TIME / TRAVEL

The switching time/travel is the time/distance that the switching system needs to get from the first opening of the previously closed contacts to the first current flow of the contacts after the snap action. Please ask for additional information for applications with a very slow actuating force or applications where the actuation of the switch is controlled by its switching process.

ACTUATING FORCE - MOVEMENT - DIAGRAM

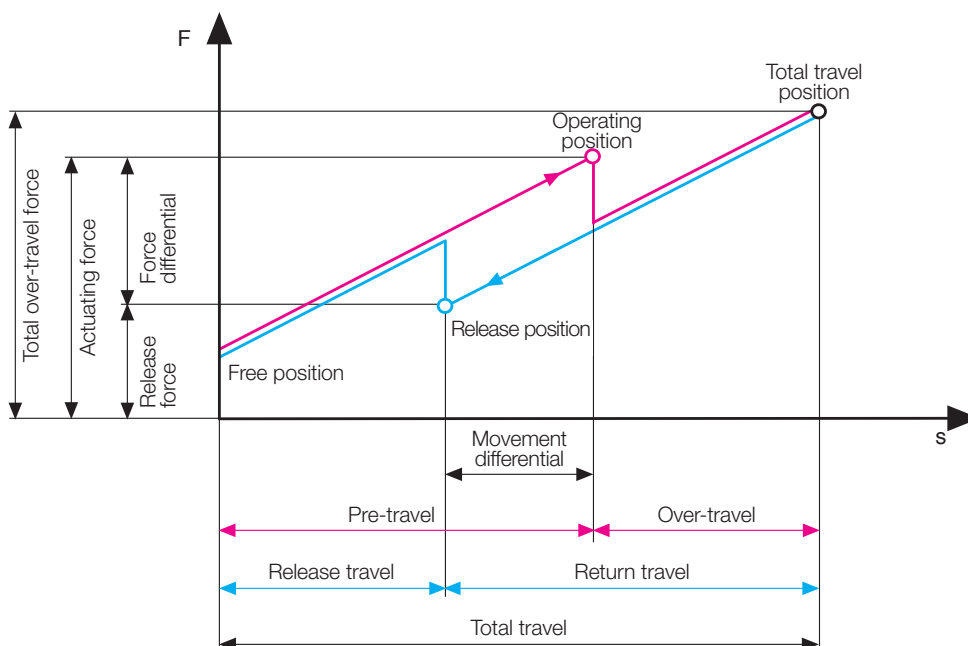

POSITIONS - FORCES - MOVEMENTS

Free position	Position of the actuator, without any influence of outside force.
Operating position	Position on the travel of the actuator, where the snap mechanism is set into function.
Total travel position	Position of the actuator at the end of the allowed travel.
Release position	Position on the travel of the actuator, where the snap mechanism starts to operate backwards.
Actuating force	Necessary force at the actuator, to bring it from the free position over the operating position.
Release force	Force, to which the actuating force has to be decreased so that the snap mechanism returns to the free position.
Force differential	Difference between actuating force and release force.
Total over-travel force	Necessary force, to keep the actuator in the permitted total traveled position.
Pre-travel	Movement between free position and operating position.
Over-travel	Movement between operating position and total traveled position.
Return travel	Movement between total traveled position and release position.
Release travel	Movement between release position and free position.
Movement differential	Movement between operating position and release position.
Total travel	Sum of pre-travel and over-travel resp. return travel and release travel.

CONTACT FORCE-MOVEMENT-DIAGRAM

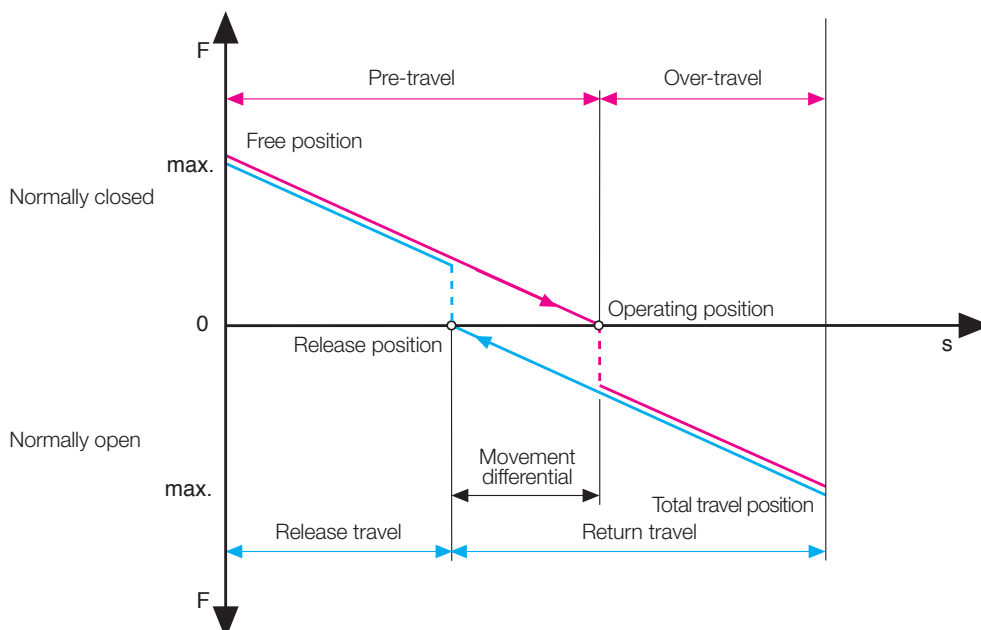

SERIES 1056/1055/1058 - ENCLOSED SNAP ACTION SWITCHES

PROTECTION TYPE IP 40 AND IP 67, UP TO 4 A 12 V / 2 A 24 V

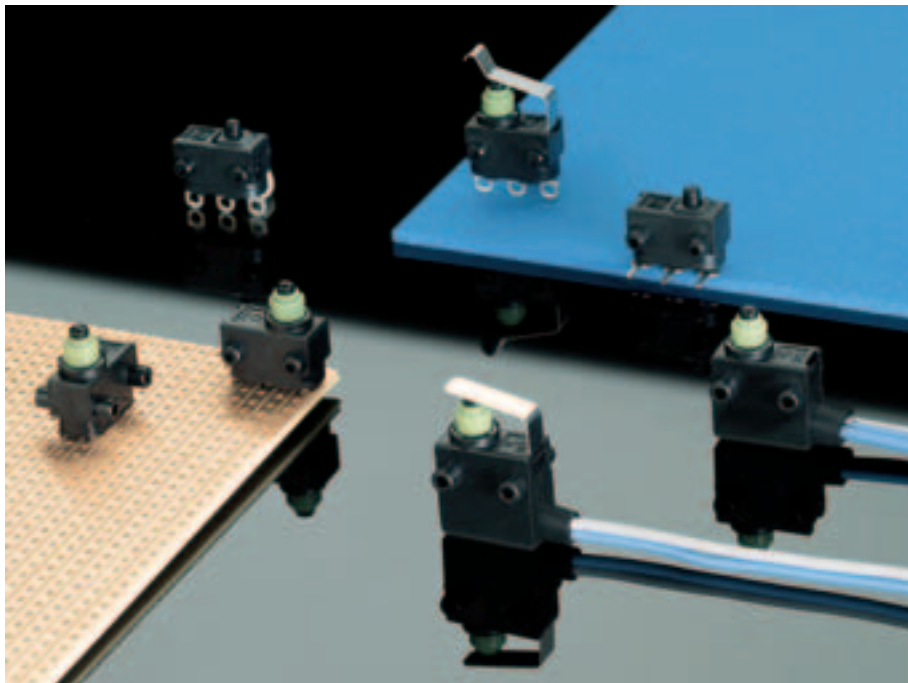

PRODUCT ADVANTAGES

- ◆ Series 1055 / 1058: compact design with dust and water proof switching system according to IP 67, versions 1058 are also protected with IP 67 from the terminal side
- ◆ Large over-travel, ≥ 1.2 mm despite small size
- ◆ Small operating point tolerances
- ◆ The special actuator design enables an approach angle up to 40°
- ◆ Switching reliability by tension spring contact system
- ◆ For electrical ratings up to 4 A 12 V resp. 2 A 24 V
- ◆ The modular principle offers a wide selection of terminals, optional actuators and types of fastenings

SWITCHING FUNCTION SERIES 1055/1056

- ◆ Change-over

SWITCHING FUNCTIONS SERIES 1058

- ◆ Change-over
- ◆ Normally open
- ◆ Normally closed

TERMINAL VERSIONS

- ◆ Solder terminal
- ◆ Straight PCB terminal
- ◆ Angled PCB terminal
- ◆ Bent PCB terminal, asymmetrical connections
- ◆ Quick-connect terminal
- ◆ Top side connection wires (only 1058)

VERSIONS ON REQUEST

- ◆ With electrical rating 0,5 (0,5) A 250 V~ 25E3 and ENEC-approval mark
- ◆ For ambient temperature $> 100^\circ\text{C}$
- ◆ Different optional actuators
- ◆ Other connection wires and different lengths

Electrical rating	4 A 12 V 2 A 24 V	
Actuating force	series 1055/1058 series 1056	$\leq 1,8$ N $\leq 1,3$ N
Mechanical life endurance	$\geq 1E6$	
Electrical life endurance	10 mA / 12 V 2 A / 12 V	$\geq 1E6$ $\geq 200E3$
Contact resistance (new state)	< 50 m Ω	
Insulation resistance (new state)	> 100 M Ω (500 V DC between the open contacts)	
Protection type series 1056 actuating side	IP 40	
terminal side	IP 00	
Protection type series 1055 actuating side	IP 67	
terminal side	IP 00	
Protection type series 1058 actuating side	IP 67	
terminal side	IP 67	
Contact gap	< 3 mm (μ)	
Ambient temperature	-40 °C ... $+85$ °C no condensation	
Storage temperature	-40 °C ... $+100$ °C	
Flammability	UL 94 V-2	
Material socket / housing / actuator	PA / PBTP / POM	
optional actuator (1055 and 1058)	chrome-nickel steel	
Contacts	AuAg plated	
Connection slits	tinned	
Solderability of terminals	max. 350 °C, 2-3 sec. (without pressure on the terminals when soldering by hand!)	
Approval mark	 on request	

APPROACH ANGLE UP TO 40°

The robust actuator guide allows actuation by slide or camshaft from all directions with an approach angle $\leq 40^\circ$.

The mechanical life depends on the material and surface properties of the slide and the installation situation in the device. The diagram opposite is also applicable to the 1056 and 1058 series.

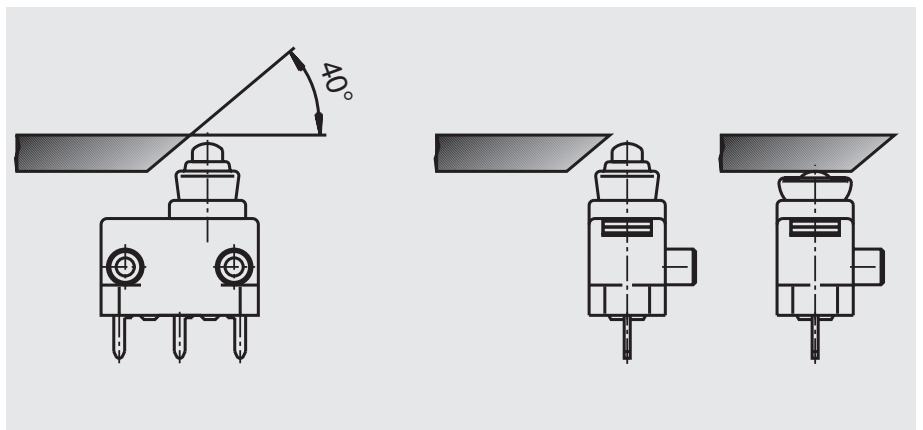

SERIES 1056/1055/1058 - ENCLOSED SNAP ACTION SWITCHES

PROTECTION TYPE IP 40 AND IP 67, UP TO 4 A 12 V / 2 A 24 V

SERIES 1056

solder terminal



1056.0351*

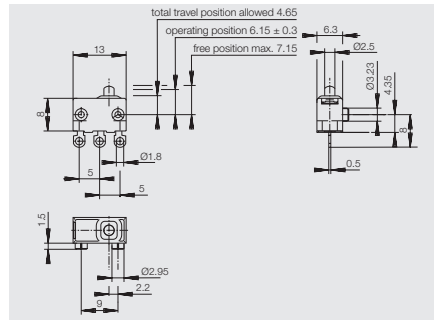

mov. differential max. 0.4 mm
pre-travel max. 1.3 mm
over-travel min. 1.2 mm

SERIES 1056

angled and straight PCB terminal



1056.3351*

1056.2351

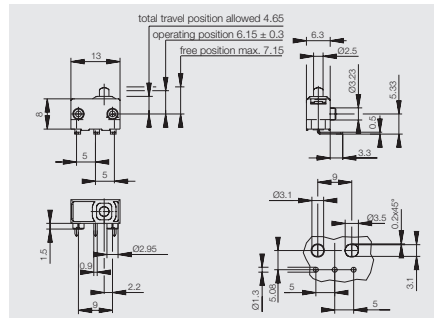

mov. differential max. 0.4 mm
pre-travel max. 1.3 mm
over-travel min. 1.2 mm

SERIES 1056

PCB terminal bent and coded



1056.3060*

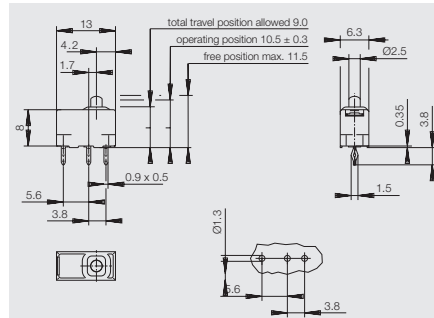

mov. differential max. 0.4 mm
pre-travel max. 1.3 mm
over-travel min. 1.2 mm

SERIES 1055

solder terminal



1055.0351*

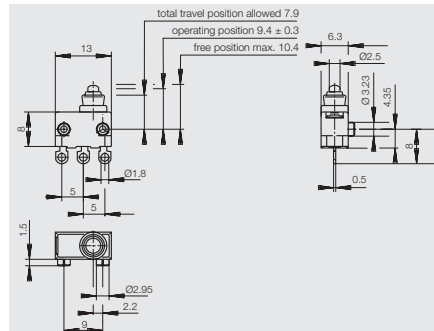

mov. differential max. 0.4 mm
pre-travel max. 1.3 mm
over-travel min. 1.2 mm

SERIES 1055

angled and straight PCB terminal



1055.3354

1055.2351

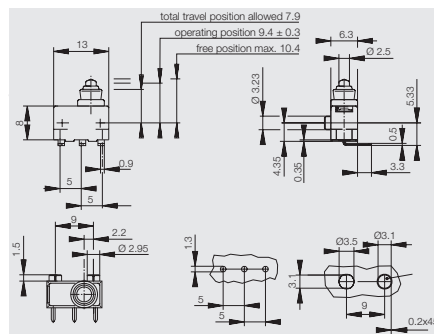

mov. differential max. 0.4 mm
pre-travel max. 1.3 mm
over-travel min. 1.2 mm

SERIES 1055

PCB terminal bent and coded



1055.2061

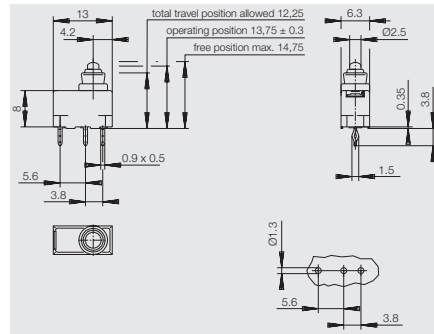

mov. differential max. 0,4 mm
pre-travel max. 1,3 mm
over-travel min. 1,2 mm

SERIES 1058

cable outlet

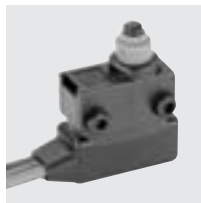

1058.0351*

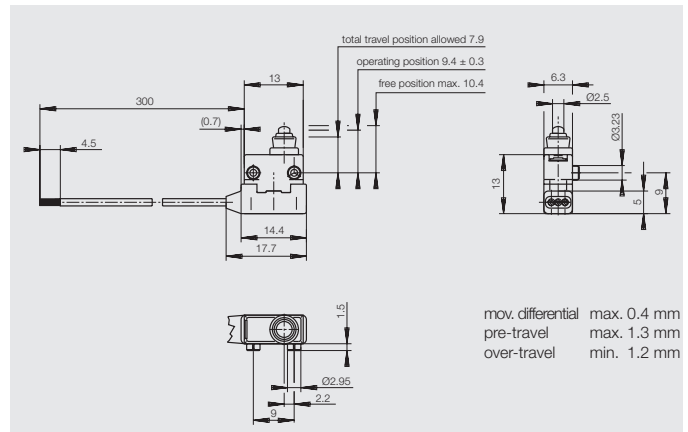

OPTIONAL ACTUATOR FOR 1055 / 1058

actuating force max. 4,2 N

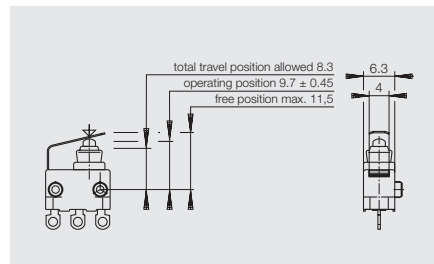

mov. differential max. 0,6 mm
pre-travel max. 2,25 mm
over-travel min. 0,95 mm

OPTIONAL ACTUATOR FOR 1055 / 1058

actuating force max. 4,2 N

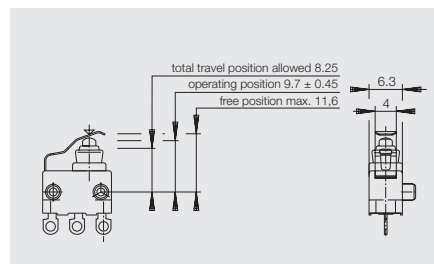

mov. differential max. 0,5 mm
pre-travel max. 2,35 mm
over-travel min. 1,0 mm

OPTIONAL ACTUATOR FOR 1055 / 1058

simulated roller

actuating force max. 2,6 N

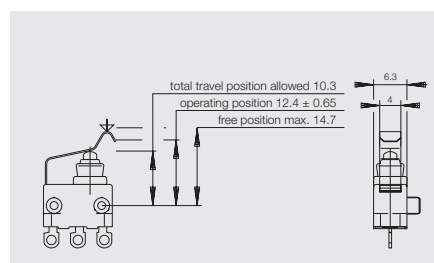

mov. differential max. 0,8 mm
pre-travel max. 2,95 mm
over-travel min. 1,45 mm

* Version on stock

SERIES 1050 - ENCLOSED SNAP ACTION SWITCHES

UP TO 10 (1,5) A 250 V~

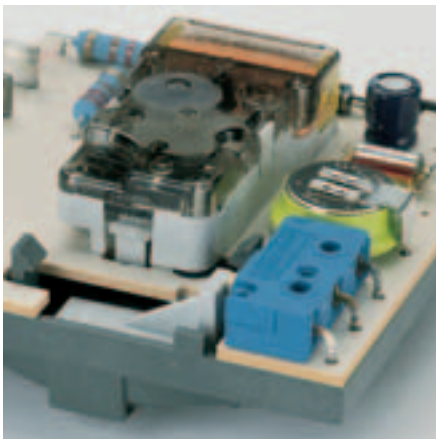
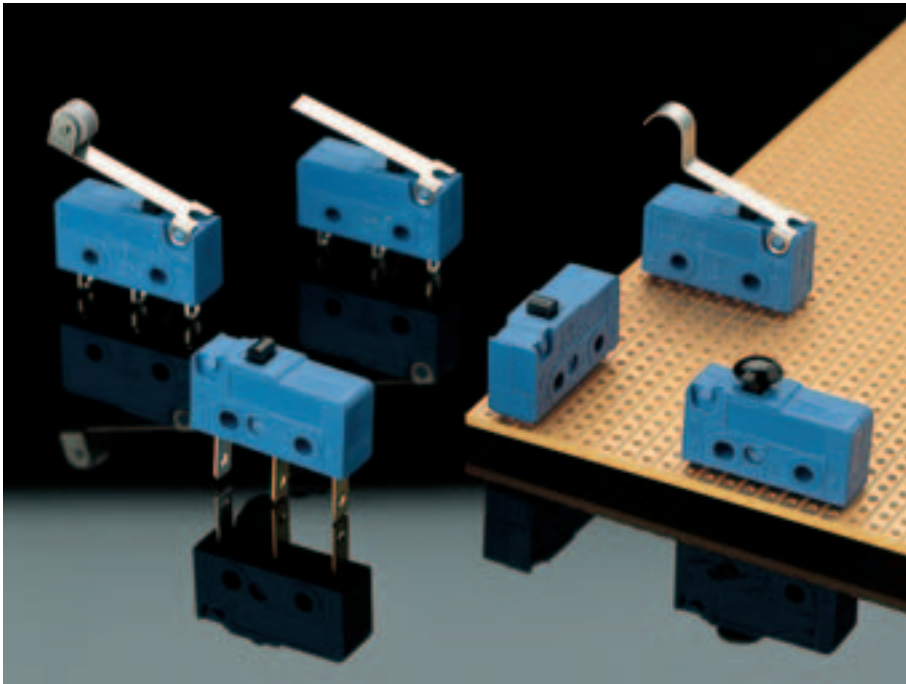

PRODUCT ADVANTAGES

- ◆ Small snap action switches in size DIN 41635 design B
- ◆ Maximum functional reliability by tension spring contact system
- ◆ Precise switching accuracy with long life endurance
- ◆ Special shape of the PCB terminals for better automatic soldering
- ◆ The versions with mushroom-head actuators can be approached from all sides
- ◆ The standard program includes a number of different ratings and terminal versions
- ◆ The optional actuators made of chrome-nickel-steel are available in different shapes and lengths. These can easily be retrofitted.

SWITCHING FUNCTIONS

- ◆ Change-over
- ◆ Normally open
- ◆ Normally closed

TERMINAL VERSIONS

- ◆ Quick-connect terminal 2.8 x 0.5 mm
- ◆ Solder terminal
- ◆ PCB terminal
- ◆ Angled PCB terminal

VERSIONS ON REQUEST

- ◆ With longer over-travel
- ◆ Approved to T 125
- ◆ With increased or reduced movement differential
- ◆ With gold-plated contacts
- ◆ With electrical rating
2 (2) A 250 V~ 25E3
Actuating force $\leq 2,2$ N
- ◆ With electrical rating
6 (2) A 250 V~ 25E3

Electrical rating (depending on version)	10 (1,5)A 250 V~ 10E3 10,1 A 125 - 250 VAC 1/4 HP
Version	DIN 41635 B
Actuating force max.	≤ 2,2 N
Mechanical life endurance	10E6 without optional actuator (1,5N-Version) 1E6 with optional actuator
Electrical life endurance	electrical rating-dependent
Contact resistance (new state)	< 100 mΩ
Insulation resistance (new state)	> 100 MΩ (500 V DC between the open contacts)
High voltage resistance (new state)	750 V eff. (between the open contacts) 1250 V (basic insulation)
Bounce time	< 5 ms
Protection type	IP 40
Resistance to tracking	PTI 175
Contact gap	< 3 mm (μ)
Ambient temperature	-40 °C ... +100 °C no condensation
Storage temperature	-40 °C ... +100 °C
Flammability	UL 94 V-2
Heat and fire-resistance	850 °C (category D)
Material	actuator PA housing PBTP optional actuator chrome-nickel steel optional actuator roller PA
Contacts	AgNi/AgNi resp. gold-plated
Material	quick-connect terminals CuZn resp. silver-plated solder terminals NC and NO tinned / COM silver-plated PCB terminals tinned and sealed to the switch
Solderability of terminals	max. 350 °C, 2-3 sec. (no pressure on the terminals when soldering by hand!)
Approval marks	
Suitable for appliances of protection class II. Required air and creepage distances within the appliances have to be observed.	

The test conditions comply with EN 61058-1 resp. UL 1054.

STANDARD VERSION

Actuating force ≤ 1,5 N
[Actuating force ≤ 2,2 N]

5 A 250 V~ 50E3
5 A 125-250 VAC 1/10 HP

10 (1,5)A 250 V~ 10E3
10,1 A 125-250 VAC 1/4 HP

2 (0,5)A 250 V~ 25E3
2 A 125-250 VAC

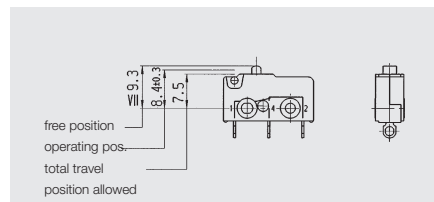

mov. differential max. 0.2 mm
pre-travel max. 1.2 mm
over-travel min. 0.6 mm

change-over

1050.1102*
 1050.0102*
 1050.2102*
 1050.3102
 1050.4102

normally open

1050.1122
 1050.0122*
 1050.2122*

normally closed

1050.1142

change-over

[1050.0103*]

contacts gold-plated

1050.1151*
 1050.2151*

* Version on stock

SERIES 1050 - ENCLOSED SNAP ACTION SWITCHES

UP TO 10 (1,5) A 250 V~

MUSHROOM HEAD ACTUATOR

Actuating force $\leq 1,5$ N

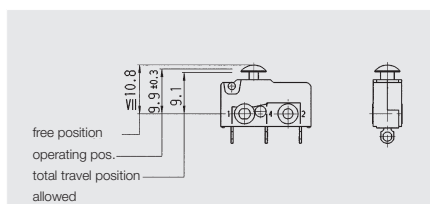

mov. differential max. 0.2 mm
pre-travel max. 1.2 mm
over-travel min. 0.5 mm

5 A 250 V~ 50E3

5 A 125-250 VAC 1/10 HP

Change-over

☐ 1050.1202*

☉ 1050.0202*

☞ 1050.2202*

2 (0,5) A 250 V~ 25E3

2 A 125-250 VAC

Contacts gold-plated

☐ 1050.4251

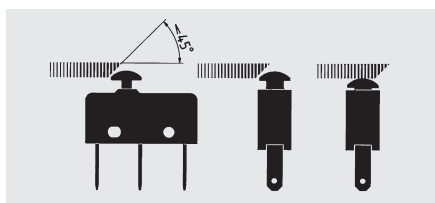

The mushroom head actuator allows actuation from all sides in addition to vertical actuation from above.

An angle of $< 45^\circ$ is necessary on the actuating element for such applications (angle for versions with longer over-travel on request). To keep the friction as low as possible, we recommend that you use materials with a low friction coefficient. The surface of the actuating element should be polished.

The mechanical life depends on the material and surface properties as well as on the design of the slide.

VERSION WITH OPTIONAL ACTUATOR

Actuating force $\leq 0,5$ N

[Actuating force $\leq 0,6$ N]

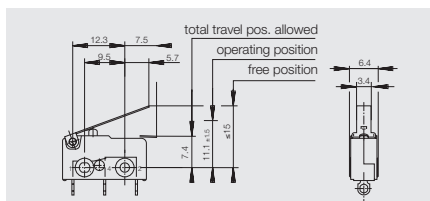

mov. differential max. 1.0 mm
pre-travel max. 5.4 mm
over-travel min. 2.2 mm

5 A 250 V~ 50E3

5 A 125-250 VAC 1/10 HP

Change-over

☉ 1050.5202*

☞ 1050.7202*

2 (0,5) A 250 V~ 25E3

2 A 125-250 VAC

Contacts gold-plated

☐ 1050.6251

☉ 1050.5251*

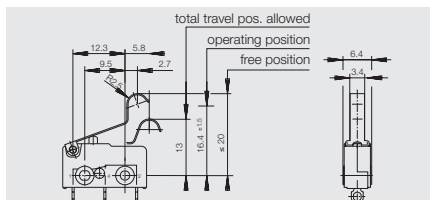

mov. differential max. 1.0 mm
pre-travel max. 5.1 mm
over-travel min. 1.9 mm

5 A 250 V~ 50E3

5 A 125-250 VAC 1/10 HP

Change-over

☐ [1050.5502*]

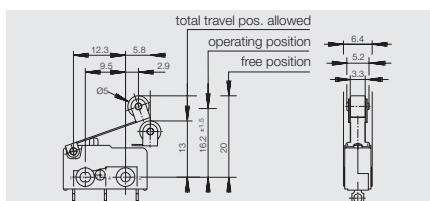

mov. differential max. 1.0 mm
pre-travel max. 5.3 mm
over-travel min. 1.7 mm

5 A 250 V~ 50E3

5 A 125-250 VAC 1/10 HP

Change-over

☐ [1050.6702*]

☉ [1050.5702*]

☞ [1050.7702*]

OPTIONAL METAL LEVERS

These optional metal levers are available as accessory parts for retrofitting.

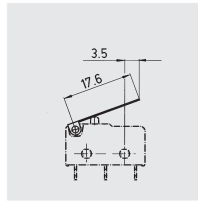

191 071 011*

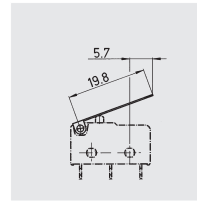

191 071 021*

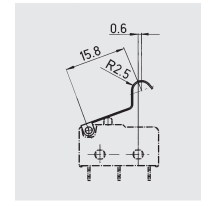

191 071 041*

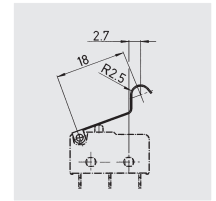

191 071 051*

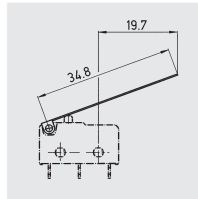

191 071 101*

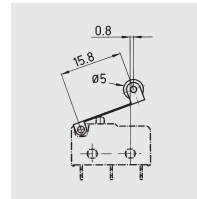

191 078 013*

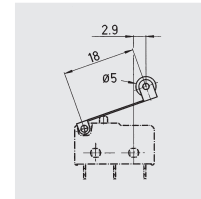

191 078 023*

OPTIONAL PLASTIC LEVERS

These optional plastic levers are available as accessory parts for retrofitting.

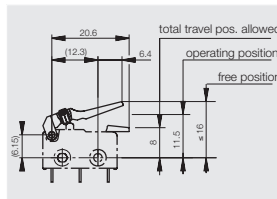

190 075 013*

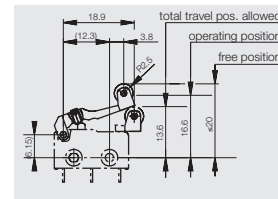

190 072 013*

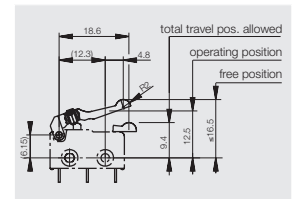

190 074 013*

DIMENSIONED DRAWINGS

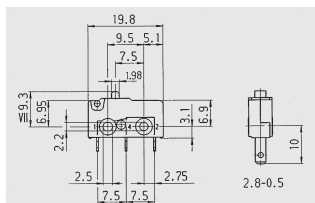

quick-connect

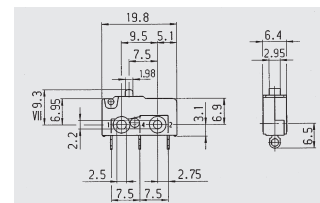

solder terminal

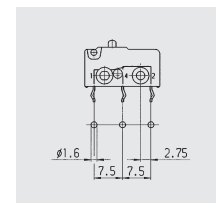

bent PCB terminal

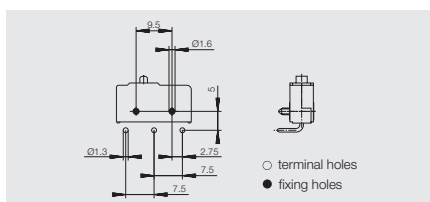

angled PCB-terminal to socket side (left)

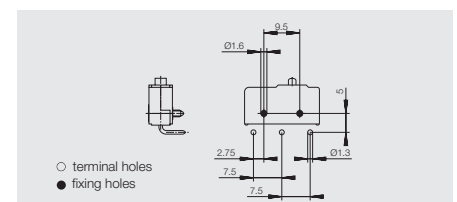

angled PCB-terminal to cover side (right)

SERIES 1080 / 1085 - ENCLOSED SNAP ACTION SWITCHES

UP TO 21 (8) A 250 V~

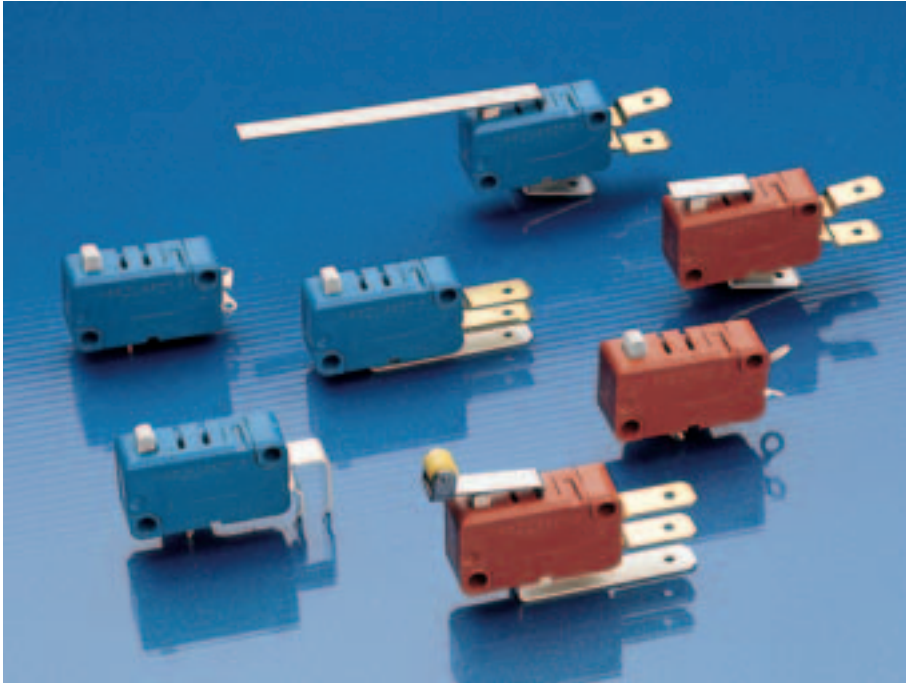

PRODUCT ADVANTAGES

- ◆ Functionally reliable snap action switches for a wide range of applications in size DIN 41635 design A
- ◆ The precise mounting of the moving contact part (milled bearing edge) offers good snap behaviour even at slow actuation
- ◆ Wide rating range of 3 (1) A 250 V~ to 21 (8) A 250 V~
- ◆ The standard program includes versions with different actuating forces, various terminals and contact gap < 3 mm or ≥ 3 mm

SWITCHING FUNCTIONS

- ◆ Change-over
- ◆ Normally open
- ◆ Normally closed

TERMINAL VERSIONS

- ◆ Quick-connect 6.3 x 0.8 mm
- ◆ Quick-connect 6.3 x 0.8 mm pitch of 5 mm or pitch of 7 mm
- ◆ Solder terminal
- ◆ Short solder terminal
- ◆ PCB terminal

VERSIONS ON REQUEST

- ◆ For ambient temperatures T 150
- ◆ Quick-connect 4.8 x 0.8 mm and 4.8 x 0.5 mm
- ◆ With gold-plated contacts
- ◆ With low actuating forces ($\leq 0,15$ N)
- ◆ With different optional actuators
- ◆ Series1085 with contact gap ≥ 3 mm for 10 (4) A 250 V~ 25E3
4 (4) A 250 V~ 50E3
- ◆ UL-electrical rating up to
21 A 125 VAC 1 HP
21 A 250 VAC 2 HP

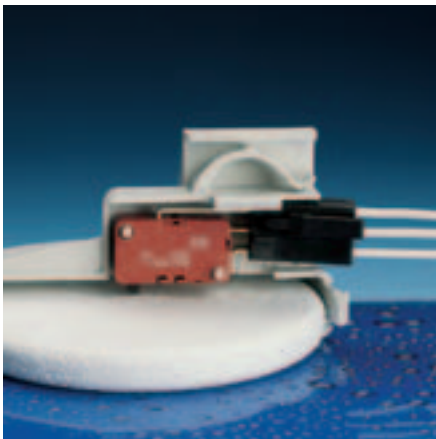

Electrical rating (depending on version)	21 (8) A 250 V~ 10E3 16 (4) A 250 V~ 25E3 21 A 125 VAC 1 HP 21 A 250 VAC 2 HP
Version	DIN 41635 A
Actuating force	series 1080 ≤ 1 N [21 (8) A-version $\leq 1,5$ N] series 1085 ≤ 4 N
Mech. life endurance	series 1080 2E6 series 1085 2E5
Electrical life endurance	electrical rating-dependent
Contact resistance (new state)	< 100 m Ω
Insulation resistance (new state)	> 100 M Ω (500 V DC between the open contacts)
High voltage resistance (new state)	750 V eff. (between the open contacts) 3750 V (reinforced insulation)
Bounce time	< 10 ms
Protection type	IP 40
Resistance to tracking	PTI 250
Contact gap 1080 / 1085	< 3 mm (μ)
Ambient temperature	-40 °C ... +125 °C no condensation
Storage temperature	-40 °C ... +80 °C
Flammability	UL 94 V-0
Heat and fire-resistance	850 °C (category D)
Material	actuator PETP housing PA / PETP optional actuator Chrome-nickel steel optional actuator roller PA
Contacts	AgCdO, AgNi resp. gold-plated
Terminals	CuZn resp. silver-plated
Solderability of terminals	max. 350 °C, 2-3 sec. (no pressure on the terminals when soldering by hand!)
Approval marks	
Suitable for appliances of protection class II. Required air and creepage distances within the appliances have to be observed.	

The test conditions comply with EN 61058-1 resp. UL 1054.

ADDITIONAL METAL LEVERS

These additional stainless steel levers are available as accessory parts for retrofitting.

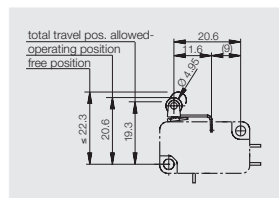

191 079 013*

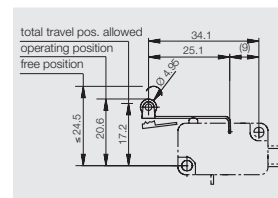

191 079 023*

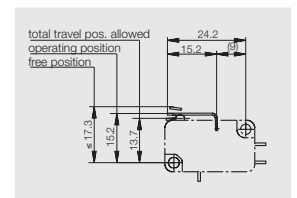

191 080 091*

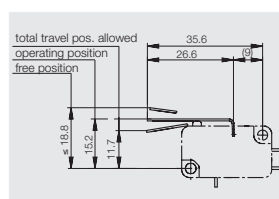

191 080 101*

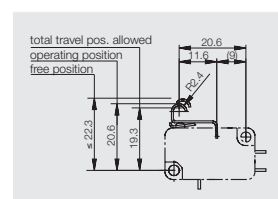

191 080 451*

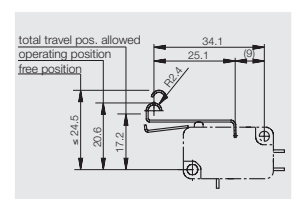

191 080 471*

* Version on stock

SERIES 1080 / 1085 - ENCLOSED SNAP ACTION SWITCHES

UP TO 21 (8) A 250 V~

SERIES 1085

Actuating force ≤ 4 N
Contact gap ≤ 3 mm

16 (4) A 250 V~ 25E3
16 A 125 VAC 1/2 HP
16 A 250 VAC 1/2 HP

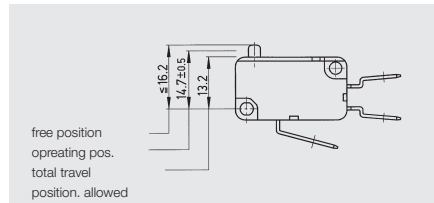

mov. differential max. 0.3 mm
pre-travel max. 2.0 mm
over-travel min. 1.0 mm

Change-over

- 1085.0403*
- 1085.0103
- 1085.0203

SERIES 1080

Actuating force ≤ 1 N
Contact gap ≤ 3 mm

16 (4) A 250 V~ 25E3
16 (8) A 250 V~ 10E3
16 A 125 VAC 1/2 HP
16 A 250 VAC 1/2 HP

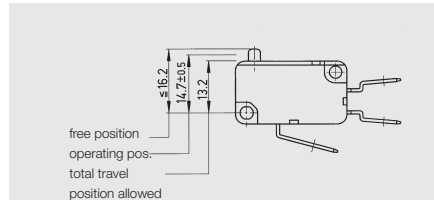

mov. differential max. 0.3 mm
pre-travel max. 2.0 mm
over-travel min. 1.0 mm

Change-over

- 1080.0403*
- 1080.0103*
- 1080.0203

DIMENSIONED DRAWINGS

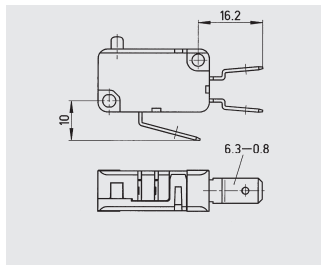
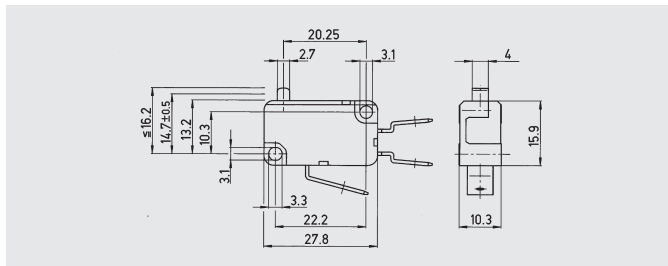

quick-connect 6.3 x 0.8 mm

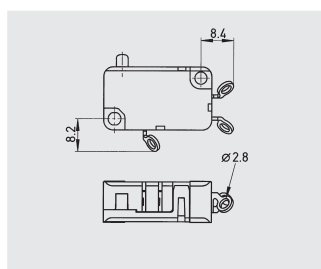

solder terminal

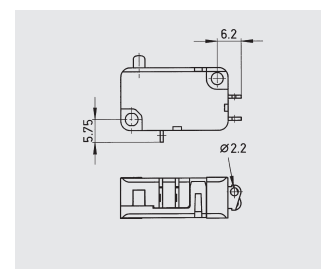

short solder terminal

SERIES 1004 / 1005 / 1006 - ENCLOSED SNAP ACTION SWITCHES

UP TO 21 (8) A 250 V~

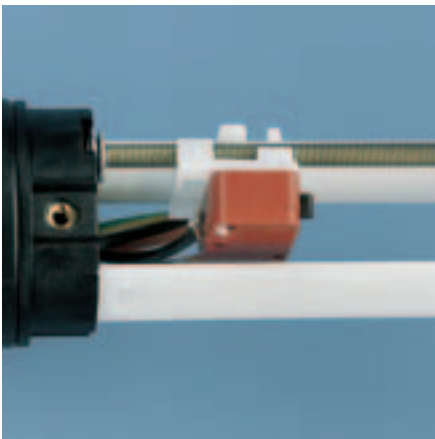
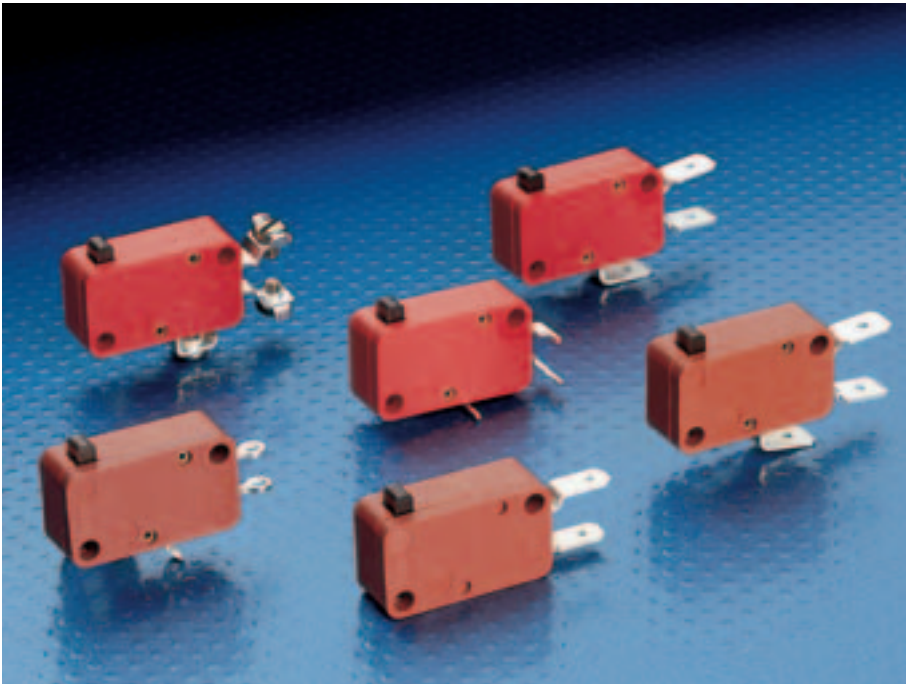

PRODUCT ADVANTAGES

- ◆ Universally applicable, proven snap action switch series with high functional reliability in size DIN 41635 design A
- ◆ Long mechanical life endurance
- ◆ Very high inrush currents
- ◆ Compulsory friction contact system, its shearing movement can free welded contacts
- ◆ Wide range of ratings from 6 (2,5) A 400 V~ to 21 (8) A 250 V~
- ◆ Contact gaps < 3 mm and \geq 3 mm
- ◆ Actuating forces of 0,2 N to 4,2 N

SWITCHING FUNCTIONS

- ◆ Change-over
- ◆ Normally open
- ◆ Normally closed

TERMINAL VERSIONS

- ◆ Solder terminal and short solder terminal
- ◆ Quick-connect 6.3 x 0.8 mm
- ◆ Quick-connect 4.8 x 0.8 mm
- ◆ PCB terminal frontal
- ◆ Angled PCB terminal

VERSIONS ON REQUEST

- ◆ Electrical rating change-over 21 (8) A 250 V~ 25E3
- ◆ Electrical rating normally open and normally closed 20 A 250 V~ 50E3
- ◆ Electrical rating normally open > 3 mm 10 (10) A 250 V~ 50E3
- ◆ Electrical rating change-over 8 (8) A 250 V~ 50E3
- ◆ For ambient temperatures T 125
- ◆ Change-over with contact gap \geq 3 mm (series 1005)
- ◆ Normally open with lateral bearing connection (series 1005)
- ◆ Quick-connect 4.8 x 0.5 mm
- ◆ Quick-connect 2.8 x 0.8 mm
- ◆ UL-electrical rating up to 21 A 125 VAC 1 HP
21 A 250 VAC 2 HP

SERIES 1004 / 1005 / 1006 - ENCLOSED SNAP ACTION SWITCHES

UP TO 21 (8) A 250 V~

Electrical rating (depending on version)		21 (8) A 250 V~ 25E3 16 (4) A 400 V~ 50E3 8 (8) A 250 V~ 50E3 21 A 125 VAC 1 HP 21 A 250 VAC 2 HP
Version		DIN 41635 A
Actuating force	series 1004 series 1005 series 1006	0,2 ... 1,8 N 1,0 ... 4,2 N 0,3 ... 4,2 N
Mechanical life endurance	< 3 mm ≥ 3 mm and lever versions	10E6 5E6
Electrical life endurance		electrical rating-dependent
Contact resistance (new state)		< 100 mΩ
Insulation resistance (new state)		>100 MΩ (500 V DC between the open contacts)
High voltage resistance (new state)	< 3 mm ≥ 3 mm	750 V (between the open contacts) 1250 V (reinforced insulation) 3750 V (reinforced insulation)
Bounce time		< 10 ms
Resistance to tracking		PTI 250
Contact gap		< 3 mm (μ) or ≥ 3 mm
Ambient temperature		-40 °C ... +100 °C no condensation
Storage temperature		-40 °C ... +80 °C
Flammability	housing actuator	UL 94 V-0 UL 94 V-0 / V-2
Heat and fire-resistance		850 °C (category D)
Material	housing / actuator optional actuator optional actuator roller	duroplast or PA chrome-nickel steel PA
Contacts		Ag/Ag resp. gold-plated
Terminals		silver-plated
Solderability of terminals	duroplast-housing thermoplast-housing	max. 350 °C, 5 sec. max. 350 °C, 2-3 sec. (no pressure on the terminals when soldering by hand)
Approval marks		
Suitable for appliances of protection class II. Required air and creepage distances within the appliances have to be observed.		

The test conditions comply with EN 61058-1 resp. UL 1054

SERIES 1005

with contact gap < 3 mm

Actuating force 1,5 ... 2,5 N
 6(2,5) A 400 V~ 50E3
 10(4) A 400 V~ 10E3
10A 125-250 VAC 1/4 HP

Actuating force 2,4 ... 3,8 N
 20(4) A 400 V~ 10E3
 16(4) A 400 V~ 50E3
 10(6) A 250 V~ 50E3
16A 125-250 VAC 1/2 HP



change-over
 □ 1005.1001*
 □ 1005.0401*

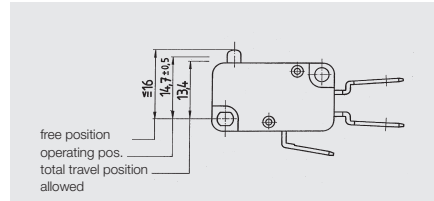

normally open □ 1005.1201*
 □ 1005.4001
normally closed □ 1005.1101

mov. differential max. 0.3 mm
 pre-travel max. 1.8 mm
 over-travel min. 0.8 mm

SERIES 1004

with low actuating forces and contact gap < 3 mm

Actuating force 0,2 ... 0,6 N
 6(2,5) A 250 V~ 50E3
4A 125-250 VAC 1/6 HP

Actuating force 0,5 ... 1,1 N
 10(4) A 250 V~ 50E3
8A 125-250 VAC 1/3 HP

Actuating force 0,8 ... 1,8 N
 16(4) A 250 V~ 25E3



change-over
 □ 1004.1002*
 □ 1004.0402

□ 1004.1001*

□ 1004.3503

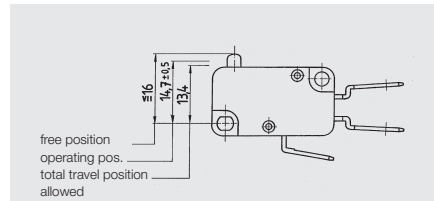

mov. differential max. 0.3 mm
 pre-travel max. 1.8 mm
 over-travel min. 0.8 mm

SERIES 1005

with contact gap ≥ 3 mm

Actuating force 2,4 ... 3,8 N
 10(6) A 250 V~ 50E3
10A 125-250 VAC 1/2 HP

Actuating force 2,6 ... 4,2 N
 10(6) A 250 V~ 50E3
10A 125-250 VAC 1/2 HP



normally open
 □ 1005.1204*
 □ 1005.0904

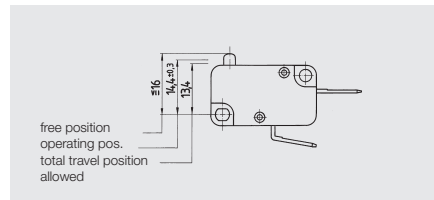

mov. differential max. 1.2 mm
 pre-travel max. 1.9 mm
 over-travel min. 0.7 mm



normally closed
 □ 1005.1105*

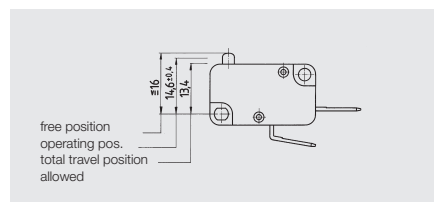

mov. differential max. 1.0 mm
 pre-travel max. 1.8 mm
 over-travel min. 0.8 mm

SERIES 1004 / 1005 / 1006 - ENCLOSED SNAP ACTION SWITCHES

UP TO 21 (8) A 250 V~

SERIES 1006

with straight metal lever
contact gap < 3 mm

actuating force 1,5 ... 2,5 N
6 (2,5) A 400 V~ 50E3
10 (4) A 400 V~ 10E3
[10 A 125-250 VAC 1/4 HP](#)



change-over
☐ 1006.1101

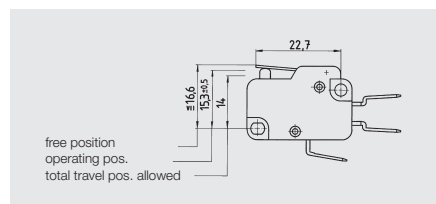

mov. differential max. 0.3 mm
pre-travel max. 1.8 mm
over-travel min. 0.8 mm

actuating force 0,8 ... 1,4 N
6 (2,5) A 400 V~ 50E3
10 (4) A 400 V~ 10E3
[10 A 125-250 VAC 1/4 HP](#)

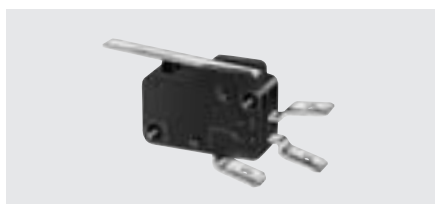

change-over
☐ 1006.1401*
☉ 1006.0901

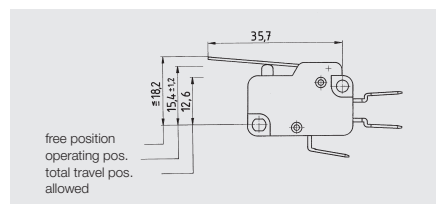

mov. differential max. 0.7 mm
pre-travel max. 4.0 mm
over-travel min. 1.6 mm

actuating force 0,30 ... 0,55 N
6 (2,5) A 400 V~ 50E3
10 (4) A 400 V~ 10E3
[10 A 125-250 VAC 1/4 HP](#)



change-over
☐ 1006.1301*

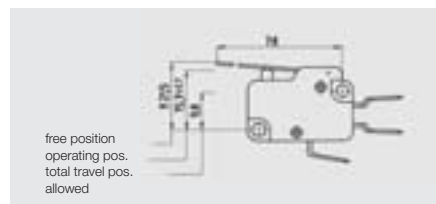

mov. differential max. 1.8 mm
pre-travel max. 8.5 mm
over-travel min. 3.2 mm

actuating force 1,5 ... 2,5 N
6 (2,5) A 400 V~ 50E3
10 (4) A 400 V~ 10E3
[10 A 125-250 VAC 1/4 HP](#)



change-over
☐ 1006.1201*
☉ 1006.0701*

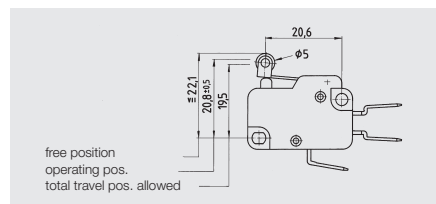

mov. differential max. 0.3 mm
pre-travel max. 1.8 mm
over-travel min. 0.8 mm

versions with 16 A or contact gap ≥ 3 mm
on request.

actuating force 0,7 ... 1,25 N
6 (2,5) A 400 V~ 50E3
10 (4) A 400 V~ 10E3
[10 A 125-250 VAC 1/4 HP](#)



change-over
☐ 1006.1511*
☉ 1006.1011*

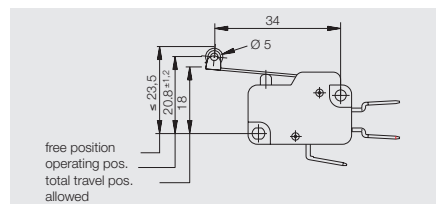

mov. differential max. 0.9 mm
pre-travel max. 3.9 mm
over-travel min. 1.6 mm

SERIES 1006

with metal spring actuator
contact gap < 3 mm

The spring actuator allows a recoil of 1.5 mm

actuating force 1,50 ... 2,50 N
6(2,5)A 400V~ 50E3
10(4)A 400V~ 10E3
10A 125-250 VAC 1/4 HP

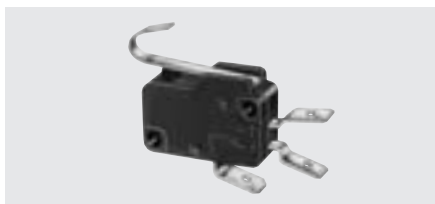

change-over
□ 1006.1801*

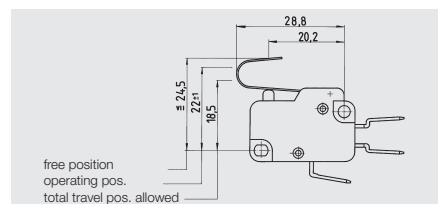

mov. differential max. 0,6 mm
pre-travel max. 3,5 mm
over-travel min. 1,0 mm
+ 1,5 mm with elastic hysteresis

INSULATING PLATES

made of hard paper HP 2061 for
mounting on metal or between
stackable switches

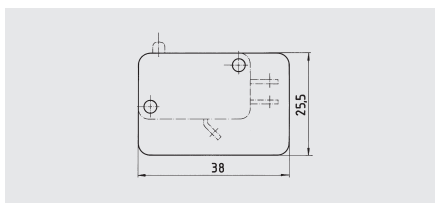

for solder terminal
thickness 0.5 mm 231 009 011*
thickness 0.8 mm 231 009 021*

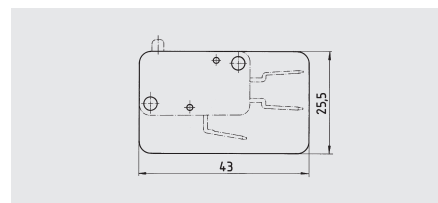

for quick-connect
thickness 0.5 mm 231 010 011*
thickness 0.8 mm 231 010 021*

DIMENSIONED DRAWINGS

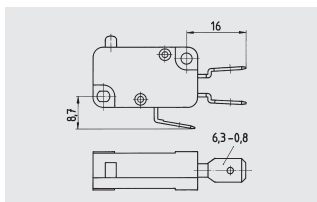
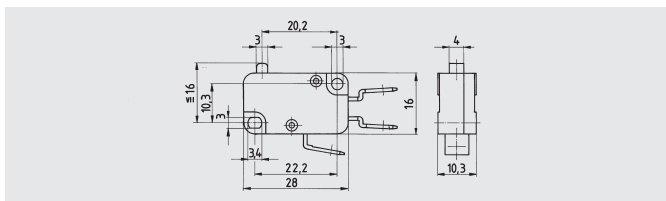

□ quick-connect

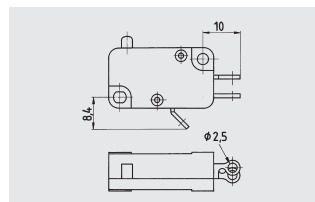

□ solder terminal

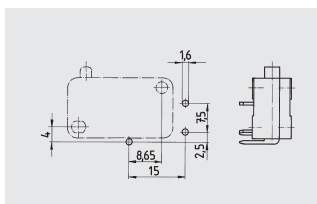

└ angled PCB-terminal to socket side (left)

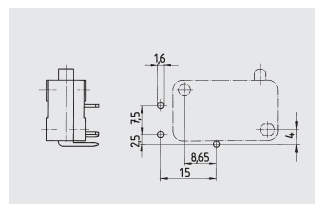

└ angled PCB-terminal to cover side (right)

SERIES 1019 - OPEN AND ENCLOSED SNAP ACTION SWITCHES

UP TO 6 (2) A 250 V~

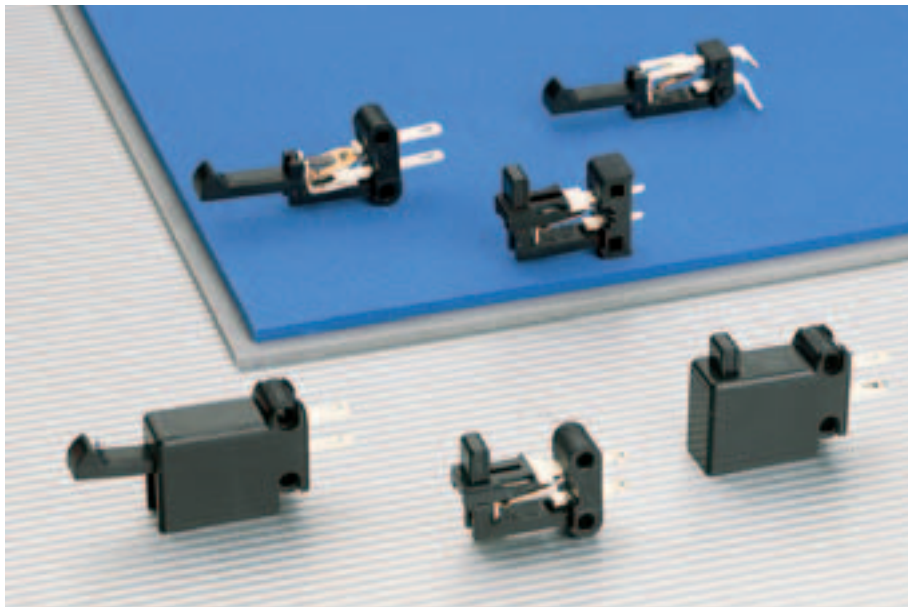

PRODUCT ADVANTAGES

- ◆ Open and enclosed snap action switches in one size with actuator or with lever
- ◆ Contact gap ≥ 3 mm
- ◆ For electrical ratings up to 6 (2) A 250 V~

SWITCHING FUNCTIONS

- ◆ Normally open
- ◆ Normally closed

TERMINAL VERSIONS

- ◆ Quick-connect
- ◆ Solder terminal
- ◆ Straight PCB terminal
- ◆ Angled PCB terminal

VERSIONS ON REQUEST

- ◆ With gold-plated contacts
- ◆ With contacts Ag/Ag
- ◆ With UL- and CSA-approval marks

Electrical rating	6 (2) A 250 V~	
Mechanical life endurance	200E3	
Electrical life endurance	electrical rating-dependent	
Contact resistance (new state)	< 100 m Ω	
Insulation resistance (new state)	> 100 M Ω (500 V DC between the open contacts)	
High voltage resistance (new state)	1250 V	
Resistance to tracking	PTI 250	
Contact gap	≥ 3 mm	
Ambient temperature	-40 °C ... +100 °C no condensation	
Storage temperature	-40 °C ... +85 °C	
Flammability	socket, lever, housing actuator	UL 94 V-0 UL 94 V-2
Heat and fire-resistance	850 °C (category D)	
Material	socket, lever, housing actuator	PA glass-fibre-reinforced PA
Contacts	Ag/Cu silver-plated	
Terminals	silver-plated	
Solderability of terminals	max. 350 °C, 2-3 sec. (no pressure on the terminals when soldering by hand!)	
Approval marks		
Suitable for appliances of protection class I. Required air and creepage distances within the appliances have to be observed.		

The test conditions comply with EN 61058-1 resp. UL 1054

OPEN VERSION

with actuator

actuating force 1,5 ... 3,0 N
6(2)A 250V~ 10E3



normally open
□▷ 1019.0101*
□▷ 1019.0301
□▷ 1019.0201*

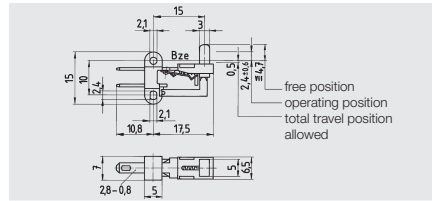

mov. differential max. 1.2 mm
pre-travel max. 2.9 mm
over-travel min. 2.3 mm

OPEN VERSION

with lever

actuating force 0,9 ... 1,7 N
6(2)A 250V~ 10E3



normally open
□▷ 1019.2101*
normally closed
□▷ 1019.3101*

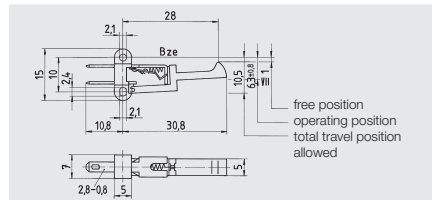

mov. differential max. 2.4 mm
pre-travel max. 6.1 mm
over-travel min. 3.4 mm

ENCLOSED VERSION

with actuator

actuating force 1,5 ... 3,0 N
6(2)A 250V~ 10E3
[5A 125-250VAC](#)



normally open
□▷ 1019.5101*
normally closed
□▷ 1019.5601*

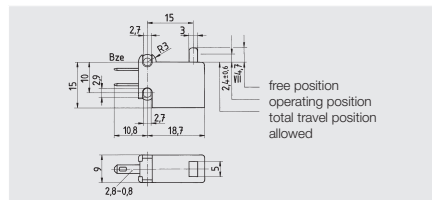

mov. differential max. 1.2 mm
pre-travel max. 2.9 mm
over-travel min. 1.8 mm

ENCLOSED VERSION

with lever

actuating force 0,9 ... 1,7 N
6(2)A 250V~ 10E3
[5A 125-250VAC](#)



normally open
□▷ 1019.5401*
normally closed
□▷ 1019.5501*

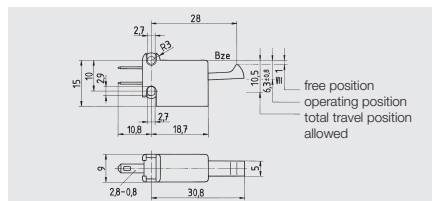

mov. differential max. 2.4 mm
pre-travel max. 6.1 mm
over-travel min. 3.4 mm

* Version on stock

SERIES 1010 - OPEN SNAP ACTION SWITCHES UP TO 10 (3) A 250 V~

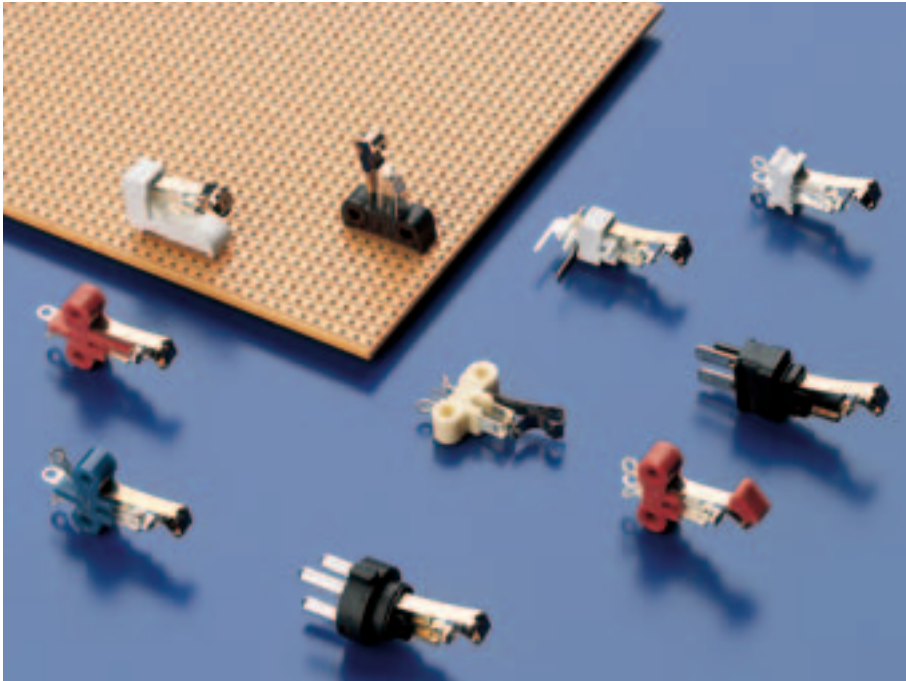

PRODUCT ADVANTAGES

- ◆ Powerful and robust snap action switch series with C-spring contact system
- ◆ Small size - large travel
- ◆ Version according to DIN 41635 C
- ◆ High switching reliability due to large contact forces
- ◆ Contact system insensitive to vibration and shock
- ◆ Short bounce time
- ◆ A large selection of socket, housing, terminal versions and actuating cams is available
- ◆ Wide range of actuating forces
- ◆ For electrical ratings up to 10 (3) A 250 V~

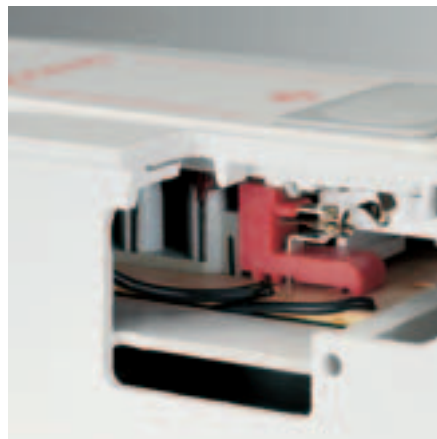

SWITCHING FUNCTIONS

- ◆ Change-over
- ◆ Normally open
- ◆ Normally closed

TERMINAL VERSIONS

- ◆ Solder terminal 9.5 mm
- ◆ Solder terminal 6.5 mm
- ◆ Straight PCB terminal
- ◆ Angled PCB terminal
- ◆ Vertical PCB terminal

VERSIONS ON REQUEST

- ◆ With longer over-travel
- ◆ With different socket designs
- ◆ With different actuating cams
- ◆ With housing
- ◆ Change-over with actuating force 0,45 ... 1,05 N, electrical rating 6 (2) A 250 V~ 25E3 
- ◆ Normally open and normally closed

Electrical rating (depending on version).	10 (3) A 250 V~
Version	DIN 41635 C
Actuating force	0,45 ... 1,05 N 0,25 ... 0,60 N
Mechanical life endurance	≥ 1E6
Electrical life endurance	electrical rating-dependent
Contact resistance (new state)	< 100 mΩ
Insulation resistance (new state)	> 100 MΩ (500 V DC between the open contacts)
High voltage resistance (new state)	750 V eff. (between the open contacts)
Bounce time	< 5 ms
Resistance to tracking	PTI 250
Contact gap	< 3 mm (μ)
Ambient temperature	-20 ... +85 °C no condensation
Storage temperature	-30 ... +80 °C
Flammability	UL 94 V-2
Heat and fire-resistance	850 °C (category D)
Material socket and actuating cams	PA
Contacts	Ag/Ag resp. gold-plated
Terminals	silver-plated
Solderability of terminals	max. 350 °C, 2-3 sec. (no pressure on the terminals when soldering by hand!)
Approval marks	partially 
Suitable for appliances of protection class I. Required air and creepage distances within the appliances have to be observed.	

The test conditions comply with EN 61058-1 resp. UL 1054

SOLDER TERMINAL 9.5 mm

actuating force 0,25 ... 0,60 N
[actuating force 0,45 ... 1,05 N]

2 (0,5) A 250 V~ 50E3 

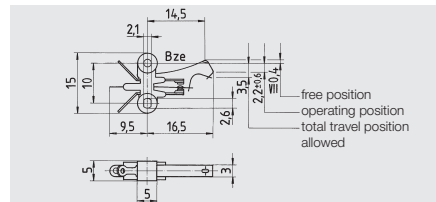

mov. differential max. 0.9 mm
pre-travel max. 3.2 mm
over-travel min. 0.7 mm

change-over
☉ 1010.0304*
☉ [1010.7302]

normally open
☉ 1010.7401*
☉ [1010.7402]

10(3) A 250 V~ 10E3 

☉ [1010.7332]

2 (0,5) A 250 V~ 50E3 

contacts gold-plated
☉ [1010.2003*]

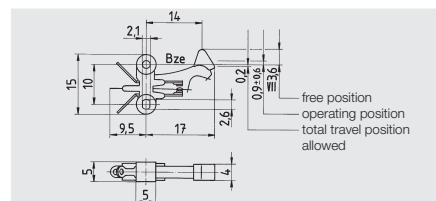

mov. differential max. 0.9 mm
pre-travel max. 3.3 mm
over-travel min. 0.5 mm

2 (0,5) A 250 V~ 50E3 

change-over
☉ 1010.3901
☉ [1010.7352]

* Version on stock

SERIES 1010 - OPEN SNAP ACTION SWITCHES UP TO 10 (3) A 250 V~

SOLDER TERMINAL 6.5 mm

actuating force 0,25 ... 0,60 N

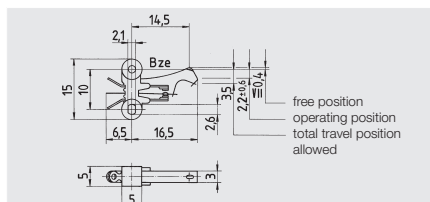

mov. differential max. 0,9 mm
pre-travel max. 3,2 mm
over-travel min. 0,7 mm

2 (0,5) A 250 V~ 50E3

change-over
1010.0101*

PCB TERMINAL

actuating force 0,25 ... 0,60 N

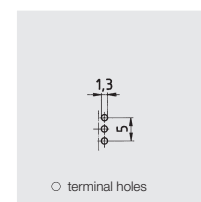
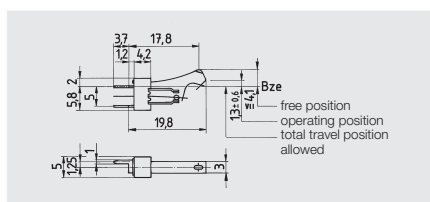

2 (0,5) A 250 V~ 50E3

change-over
1010.4402

mov. differential max. 0,9 mm
pre-travel max. 3,4 mm
over-travel min. 0,7 mm

2 (0,5) A 250 V~ 50E3

change-over
1010.6003

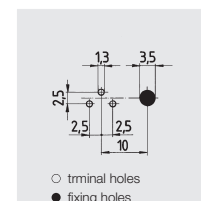
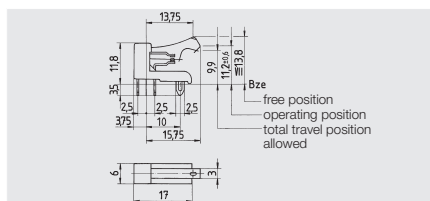

mov. differential max. 0,9 mm
pre-travel max. 3,2 mm
over-travel min. 0,7 mm

PCB TERMINAL

actuating force 0,45 ... 1,05 N

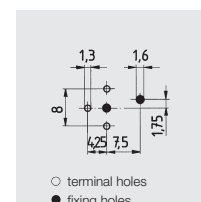
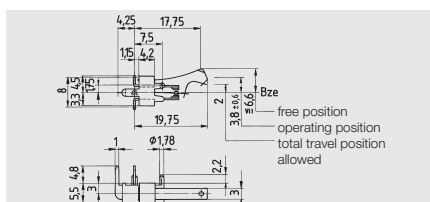

2 (0,5) A 250 V~ 50E3
6 (2) A 250 V~ 25E3



change-over
1010.9802*

Differenzweg max. 0,9 mm
Vorlaufweg max. 3,4 mm
Nachlaufweg min. 1,2 mm

contacts gold-plated
1010.9705*

Mechanical life endurance
over-travel 0,7 mm = 1E6
over-travel 1,2 mm = 1E5

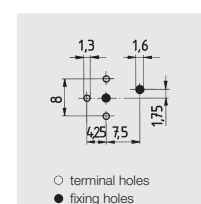
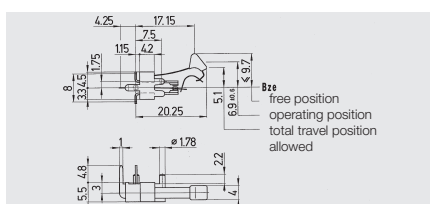

change-over
1010.9752*
1010.9852*

mov. differential max. 0,9 mm
pre-travel max. 3,4 mm
over-travel min. 1,2 mm

SERIES 1011 - BI-STABLE SNAP ACTION SWITCHES

UP TO 6 (2) A 250 V~

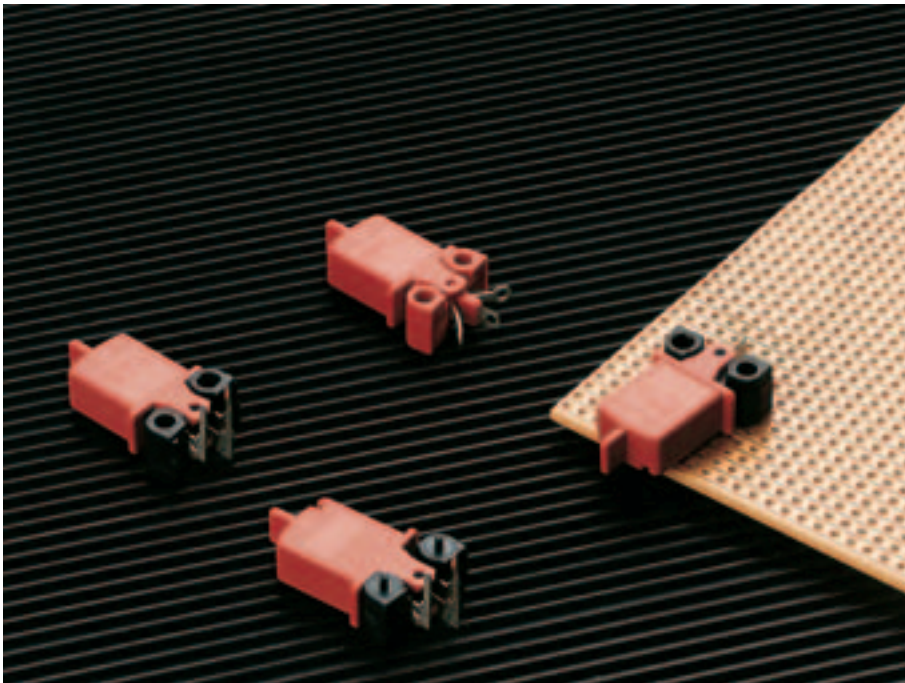

PRODUCT ADVANTAGES

- ◆ Powerful and robust snap action switch series with C-spring contact system
- ◆ Small size - large travel
- ◆ High switching reliability due to large contact forces
- ◆ Contact system insensitive to vibration and shock
- ◆ Short bounce time

SWITCHING FUNCTIONS

- ◆ DT-switch

TERMINAL VERSIONS

- ◆ Solder terminal
- ◆ Angled PCB terminal

Electrical rating	6(2) A 250 V~ 50E3
Actuating force	0,2 ... 0,7 N
Mechanical life endurance	200E3
Electrical life endurance	50E3
Contact resistance (new state)	< 100 mΩ
Resistance to tracking	PTI 250
Contact gap	< 3 mm (μ)
Ambient temperature	-25 °C ... +85 °C no condensation
Storage temperature	-40 °C ... +85 °C
Material socket and housing	PA
Contacts	Ag/Ag
Terminals	silver-plated

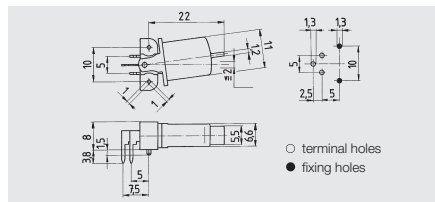

over-travel min. 0.85 mm
(to each direction)
total travel 5.2 ± 1.5 mm

DT-switch

┌ 1011.5101

SERIES 1022 - ENCLOSED SNAP ACTION SWITCHES

PROTECTION TYPE IP 67, UP TO 4 A 12V / 2 A 24V

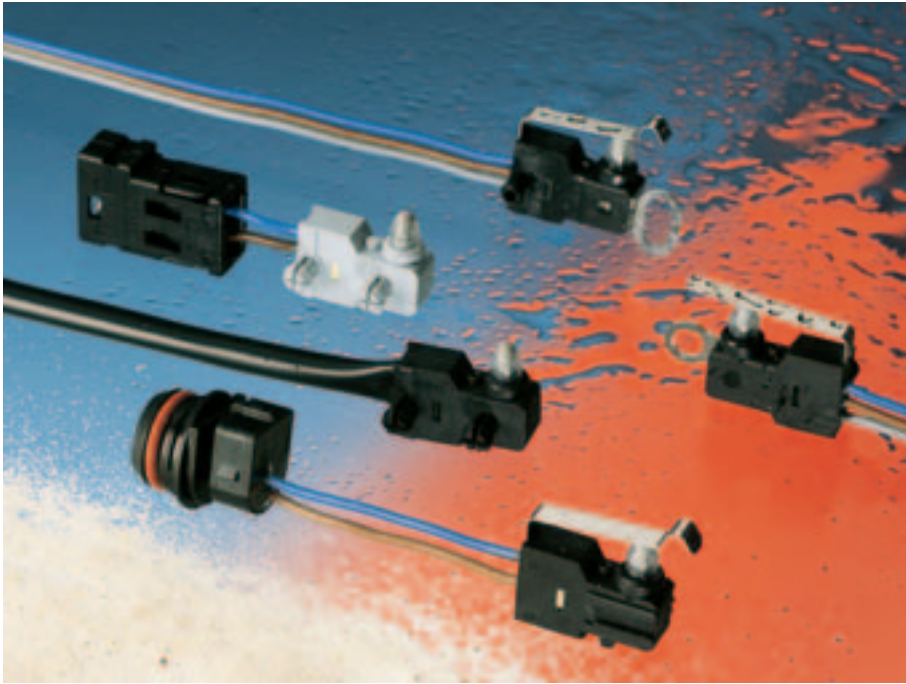

PRODUCT ADVANTAGES

- ◆ Small size - large travel
- ◆ For extreme operating conditions, e.g. automobiles or electrical appliances in wet areas
- ◆ Dust and water proof IP 67 by special sealing of the actuator and terminals
- ◆ Lever bearing protected from freezing
- ◆ High switching reliability due to large contact forces directly after switching
- ◆ C-spring contact system insensitive to shock and vibration
- ◆ Series with different housings, optional actuators and fastening options

SWITCHING FUNCTIONS

- ◆ Change-over
- ◆ Normally open
- ◆ Normally closed

TERMINAL VERSIONS

- ◆ Connection wires

VERSIONS ON REQUEST

- ◆ With different optional actuators
- ◆ Packaged version due to special housing designs



Electrical rating	4 A 12 V 2 A 24 V
Actuating force	≤ 2,5 N
Mechanical life endurance	≥ 100E3
Electrical life endurance	electrical rating-dependent
Contact resistance (new state)	< 100 mΩ
Insulation resistance (new state)	> 100 MΩ (500 V DC between the open contacts)
Bounce time	< 5 ms
Protection type	IP 67
Resistance to tracking	PTI 250
Contact gap	< 3 mm (μ)
Ambient temperature	-40 °C ... +85 °C no condensation briefly up to 120 °C
Storage temperature	-40 °C ... +100 °C
Flammability	UL 94 V-2
Material housing / actuator	PBTP / POM
Material optional actuator	chrome-nickel steel
Contacts	AuAg plated
Connection wires	0.5 mm ² cast in switch, 500 mm long, tinned ends

STANDARD VERSIONS

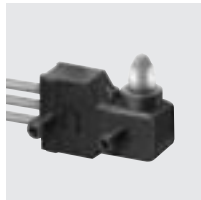

change-over
1022.0101

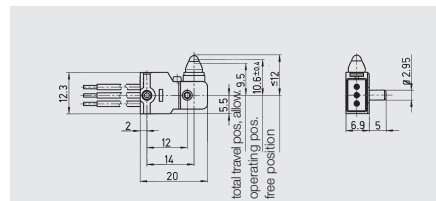

mov. differential max. 0.6 mm
pre-travel max. 1.8 mm
over-travel min. 0.7 mm

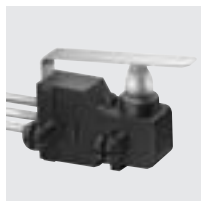

change-over
1022.2201

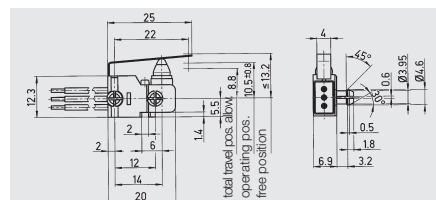

mov. differential max. 1.0 mm
pre-travel max. 3.5 mm
over-travel min. 0.9 mm



change-over
1022.4501*

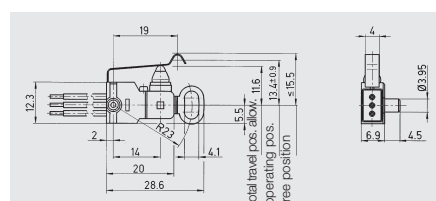

mov. differential max. 1.0 mm
pre-travel max. 3.0 mm
over-travel min. 0.9 mm

adjustable by ± 2 mm by means of elongated hole fastening

SERIES 1117 - ENCLOSED SNAP ACTION SWITCHES FOR

16 (6) A 400 V~

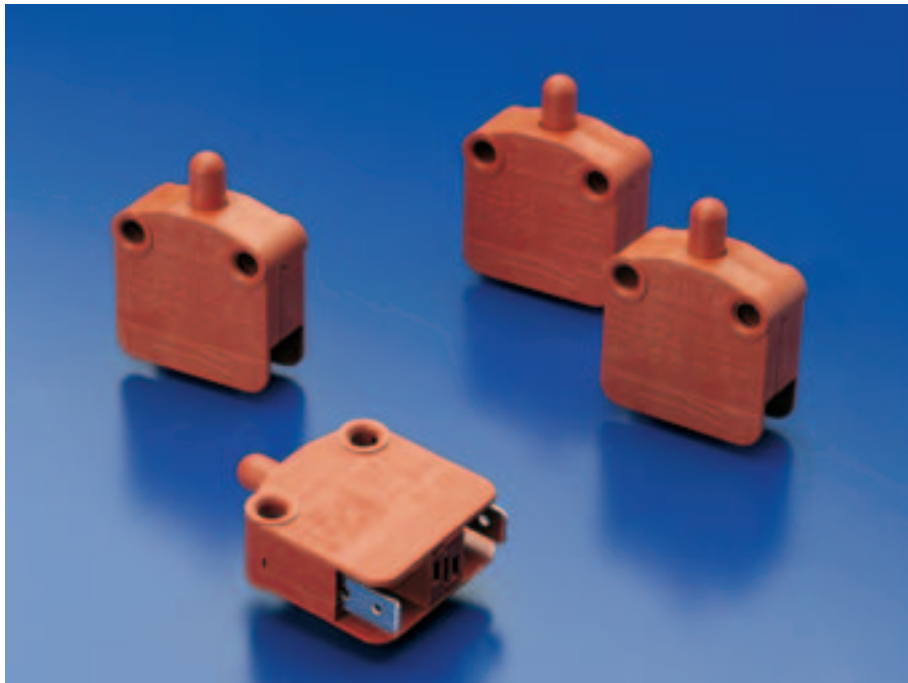

PRODUCT ADVANTAGES

- ◆ Switching system (spring contact), proven a million times
- ◆ Contact gap ≥ 3 mm
- ◆ For voltages up to 400V~
- ◆ Contact system with bridging contacts
- ◆ Housing and actuator self-extinguishing (UL 94 V-0)
- ◆ Large over-travel allows wide tolerance compensation
- ◆ Actuator can be approached from all directions

SWITCHING FUNCTIONS

- ◆ Normally open
- ◆ Normally closed

TERMINAL VERSIONS

- ◆ Quick-connect

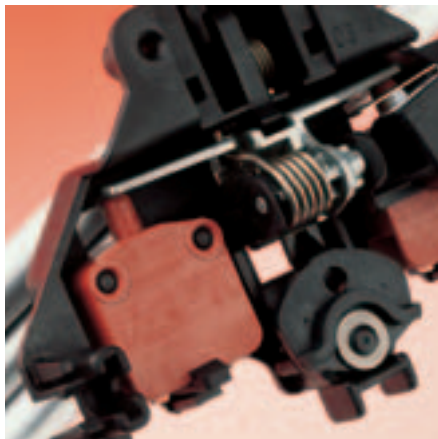

Electrical rating	16 (6) A 400 V~ 10E3 12 A 125 - 250 VAC 1/6 HP 125 VAC 1/2 HP 250 VAC
Actuating force	≤ 4 N
Mechanical life endurance	100E3
Electrical life endurance	electrical rating-dependent
Contact resistance (new state)	< 100 mΩ
Insulation resistance (new state)	> 100 MΩ (500 V DC between the open contacts)
High voltage resistance (new state)	1500 V eff. (between the open contacts) 3750 V (reinforced insulation)
Resistance to tracking	PTI 250
Protection type	IP 40
Contact gap	≥ 3 mm
Insulation distance	≥ 8 mm
Ambient temperature	-40 °C ... +85 °C no condensation
Storage temperature	-40 °C ... +85 °C
Flammability actuator and housing	UL 94 V-0
Heat and fire-resistance	850 °C (category D)
Material housing and actuator	PA
Contacts	Ag/Ag
Terminals	CuAg
Push-on force of connectors	≤ 80 N
Approval marks	
Suitable for appliances of protection class II	

The test conditions comply with EN 61058-1 resp. UL 1054



normally open
□ 1117.0101*

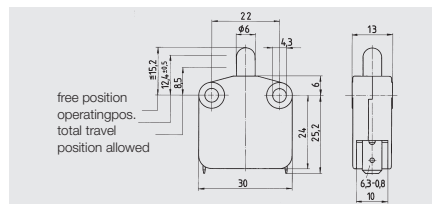

mov. differential max. 2.3 mm
pre-travel max. 3.3 mm
over-travel min. 3.4 mm



normally closed
□ 1117.0201*

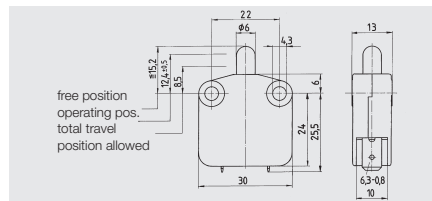

mov. differential max. 2.3 mm
pre-travel max. 3.3 mm
over-travel min. 3.4 mm

SERIES 1040 - ENCLOSED SNAP ACTION SWITCHES UP TO 4 (1) A 250 V~ WITH ROTARY SHAFT ACTUATION

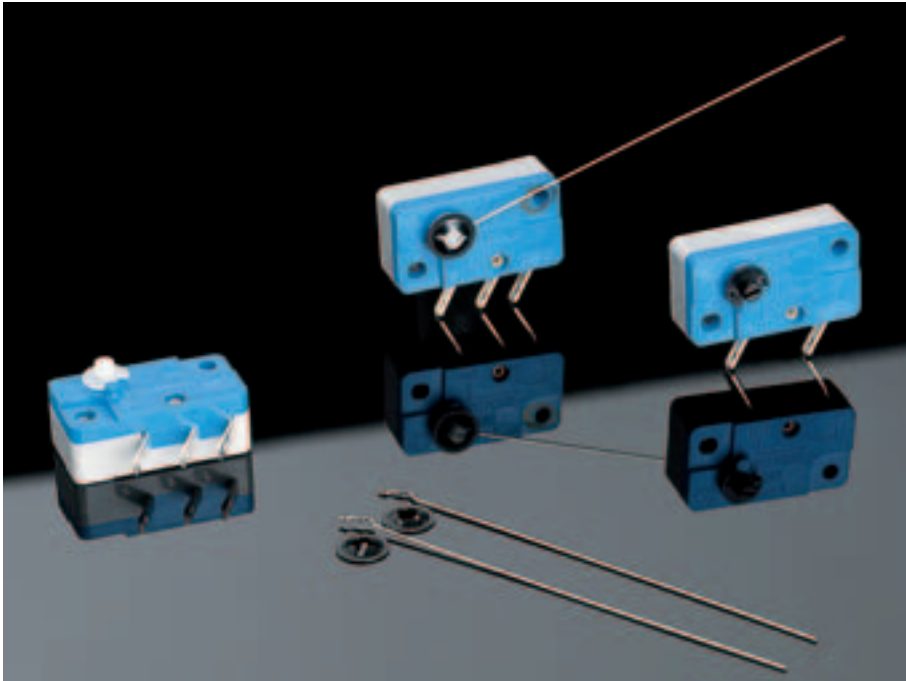

PRODUCT ADVANTAGES

- ◆ For actuating by a rotary shaft
- ◆ For electrical ratings up to 4 (1) A 250 V~
- ◆ VDE approval mark

SWITCHING FUNCTIONS

- ◆ Change-over
- ◆ Normally open

TERMINAL VERSIONS

- ◆ Quick-connect

VERSIONS ON REQUEST

- ◆ With actuating torque 0.6 ... 0.9 Nmm
- ◆ With gold-plated contacts

Electrical rating	4 (1) A 250 V~ 50E3
Moment of actuation	0,9 ... 1,7 Nmm
Mechanical life endurance	5E6
Electrical life endurance	electrical rating-dependent
Contact resistance (new state)	< 100 mΩ
Insulation resistance (new state)	> 100 MΩ (500 V DC between the open contacts)
High voltage resistance (new state)	750 V eff. (between the open contacts)
Protection type	IP 40
Resistance to tracking	PTI 250
Contact gap	< 3 mm (μ)
Ambient temperature	-35 °C ... +85 °C no condensation
Storage temperature	-35 °C ... +80 °C
Flammability	UL 94 V-2
Heat and fire-resistance	850 °C
Material	socket / cover / shaft optional actuator
	PBTP (blue) / PA / PA spring steel Ø 0.6 mm
Contacts	Ag/Ag
Terminals	silver-plated
Approval mark	△
Suitable for appliances of protection class II. Required air and creepage distances within the appliances have to be observed.	

The test conditions comply with EN 61058-1 resp. UL 1054

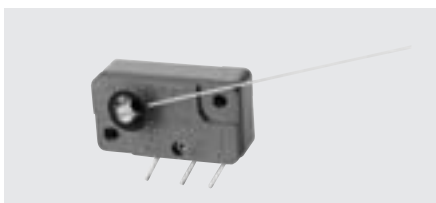

change-over

1040.0114*

3.32 MARQUARDT

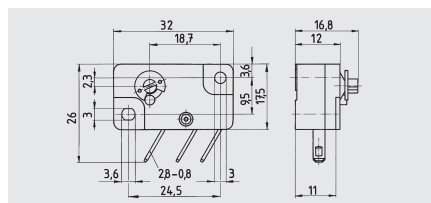

* Version on stock

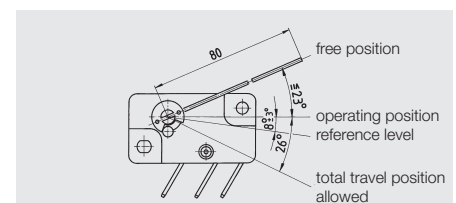

differential angle max. 15°
pre-travel angle max. 34°
over-travel angle min. 15°

SERIES 1017 - OPEN LEAF SWITCHES WITHOUT SNAP FUNCTION

FOR ELECTRICAL RATINGS UP TO 100 mA 24 V

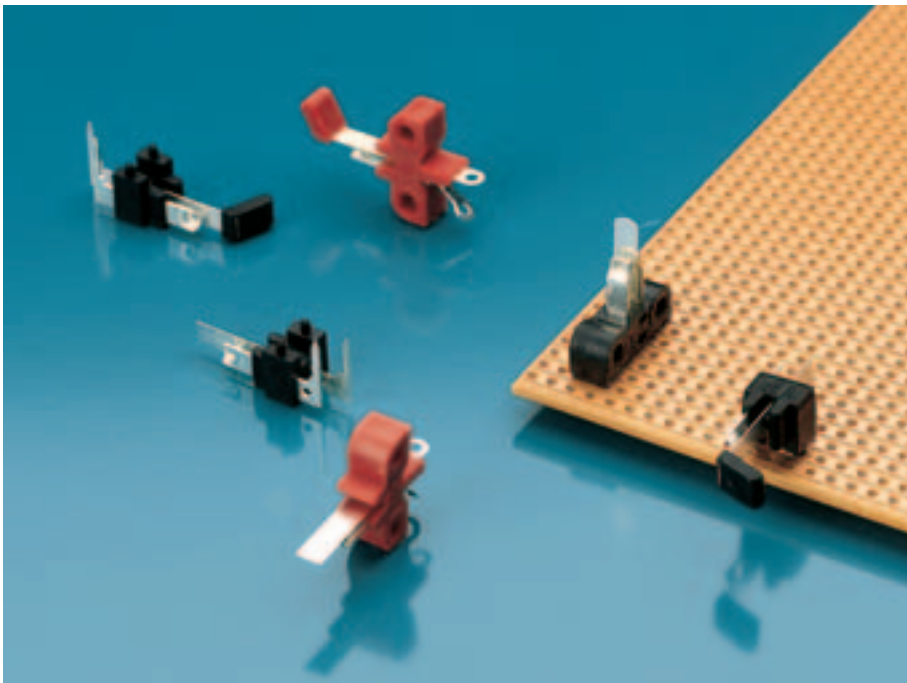

PRODUCT ADVANTAGES

- ◆ Low-cost alternative to open snap action switches
- ◆ Low actuating forces
- ◆ Large actuating travels
- ◆ Low space requirements
- ◆ Same dimensions for fastening holes and terminals as in the 1010 snap action switch series

SWITCHING FUNCTIONS

- ◆ Normally open
- ◆ Change-over with centre-OFF

TERMINAL VERSIONS

- ◆ Solder terminal
- ◆ Straight PCB terminal
- ◆ Angled PCB terminal

VERSIONS ON REQUEST

- ◆ With gold-plated contacts
- ◆ With actuating cam

Electrical rating	100 mA 24 V
Actuating force	0,15 ... 0,50 N
Mechanical life endurance	1E6
Electrical life endurance	electrical rating-dependent
Resistance to tracking	PTI 250
Contact gap	< 3 mm (μ)
Ambient temperature	-25 °C ... +85 °C no condensation
Storage temperature	-40 °C ... +80 °C
Flammability	UL 94 V-2
Material socket and actuating cams	PA
Contact	silver-plated / gold-plated
Terminals	silver-plated
Solderability of terminals	max. 350 °C, 2-3 sec. (no pressure on the terminals when soldering by hand!)

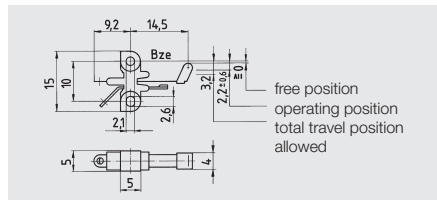

normally open

1017.0801

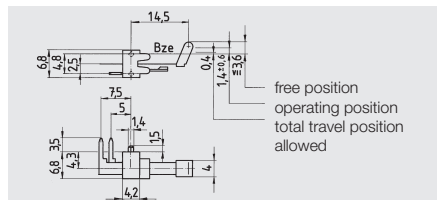
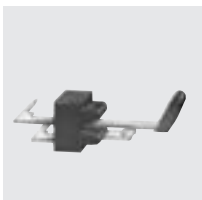

normally open

1017.5701

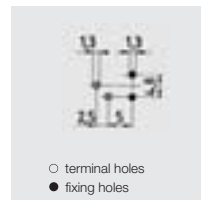

* Version on stock

1



TECHNICAL INFORMATION

Pages 1.1 - 1.5

2



APPLIANCE SWITCHES

Pages 2.1- 2.48

3



SNAP ACTION SWITCHES

Pages 3.1 - 3.33

4

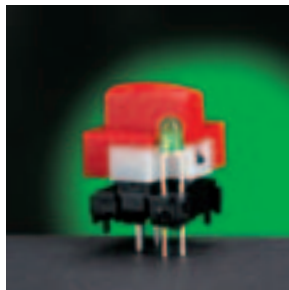

KEYMODULES

Pages 4.1 - 4.9

5

INDEX OF PART NUMBERS

Pages 5.1 - 5.3

SERIES 6425 - KEYMODULES

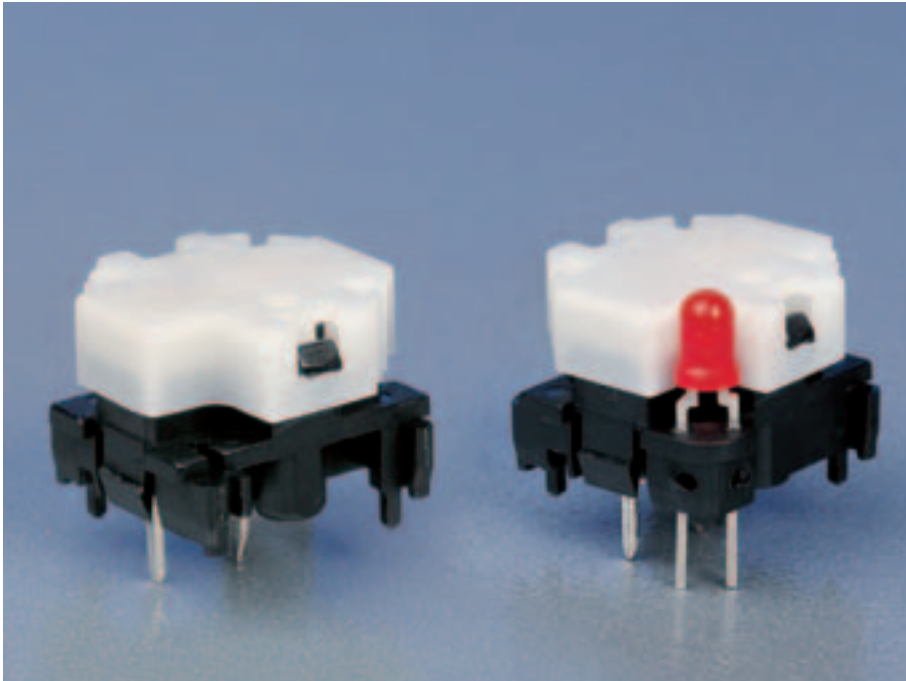

PRODUCT ADVANTAGES

- ◆ Single pole NO with and without LED
- ◆ High life endurance
- ◆ Gold contacts guarantee secure switching function
- ◆ Short bounce time
- ◆ Comfortable actuation characteristic and low operating noise
- ◆ Low profile
- ◆ The keymodules are suitable for automatic soldering

TECHNICAL DATA

- ◆ Voltage 28 V max.
- ◆ Current 100 mA max.
- ◆ Life endurance > 10⁶ cycles at 10 mA 12 V
- ◆ Contact resistance < 250 mΩ
- ◆ Insulation resistance (new state) > 100 MΩ
- ◆ Bounce time typical < 5 ms
- ◆ Ambient temperature -20 ... +70 °C
- ◆ Storage temperature -55 ... +75 °C
- ◆ Actuating force approx. 0,7 N
- ◆ Total travel max. 1.6 mm
- ◆ Housing made of thermoplastic material
- ◆ Contact material gold
- ◆ Terminals tinned



6425.0101*

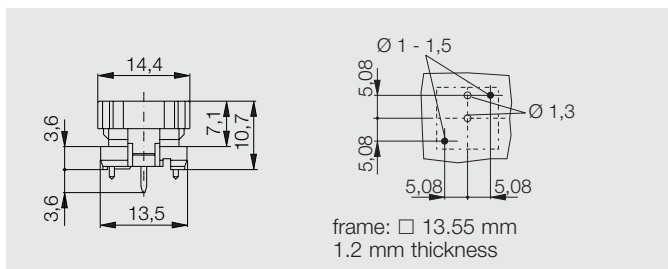

for all single keycaps with spacing 16 mm or 19 mm



6425.1101*

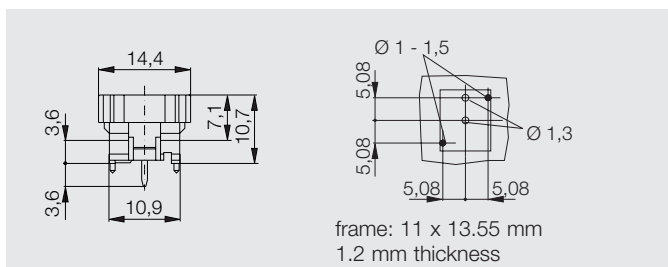

for guide mechanism, keymodules with narrow socket

SPECIAL NOTES

- ◆ For use of keymodules with integrated LED a current limitation to max. 20 mA is necessary.

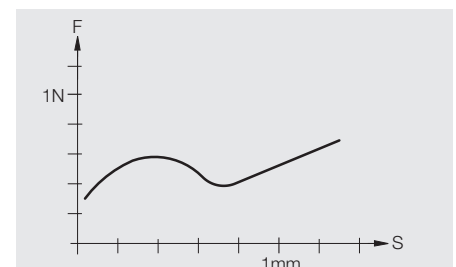

Actuating force / travel diagram

VERSION WITH LED

for square keycaps 829 000 . . .
(page 4.4) with spacing 16 mm.

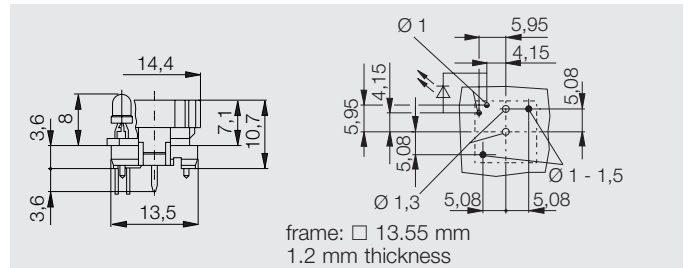

- 6425.4111 LED red*
- 6425.4121 LED yellow
- 6425.4131 LED green

VERSION WITH LED

for square keycaps 828 000 . . .
(page 4.4) with spacing 19 mm.

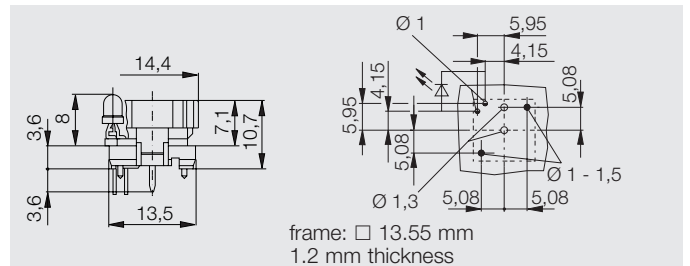

- 6425.3111 LED red*
- 6425.3121 LED yellow
- 6425.3131 LED green

VERSION WITH LED

for keycaps with small surface area
827 (page 4.6) with spacing
16 mm resp. > 15 mm .

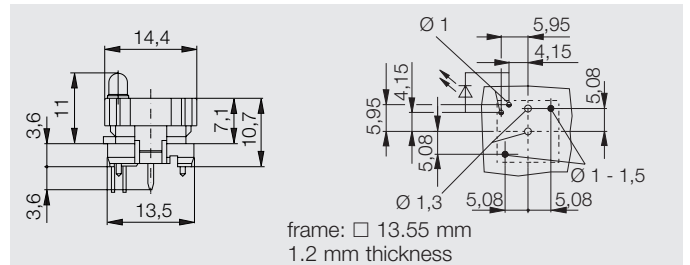
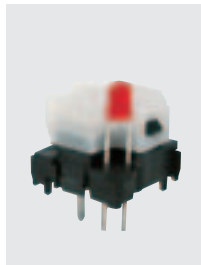

- 6425.6111 LED red*
- 6425.6121 LED yellow
- 6425.6131 LED green

KEYMODULE

prepared for on-site assembly of a LED.

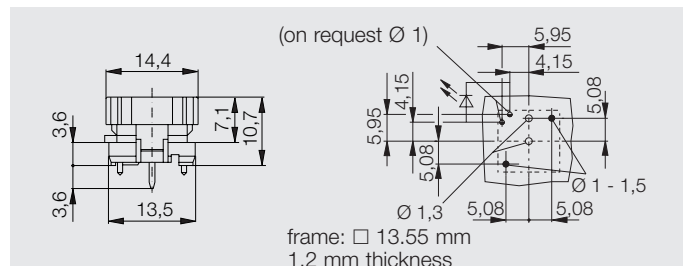

6425.2101

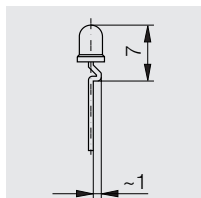

spacing 16 mm

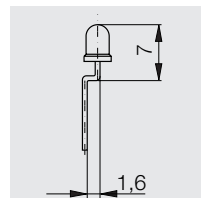

spacing 19 mm

* Version on stock

KEYCAPS WITH AND WITHOUT LED WINDOW

FOR KEYMODULES OF SERIES 6425

SQUARE KEYCAPS

with ergonomic surface area. For spacing 16 mm and 19 mm.

different colours and characters on request

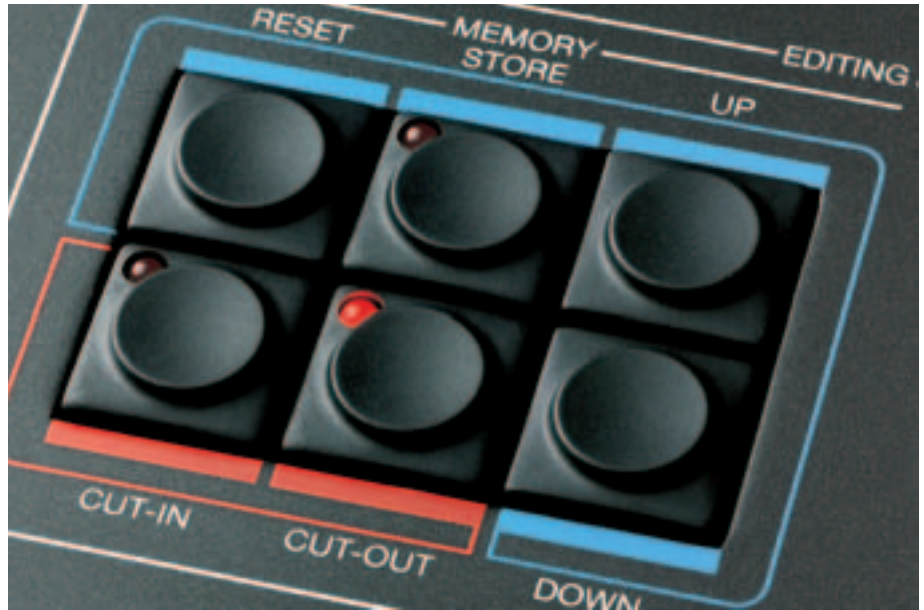

WITHOUT LED WINDOW

spacing 16 mm
spacing 19 mm

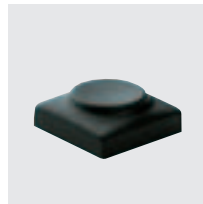

826 000 011*
825 000 011*

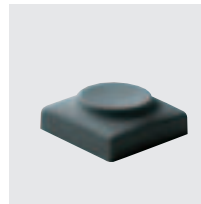

826 000 021*
825 000 021*



826 000 071*
825 000 071*



826 000 091*
825 000 091*

WITH LED WINDOW

spacing 16 mm
spacing 19 mm

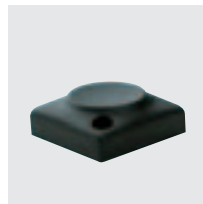

829 000 011*
828 000 011*

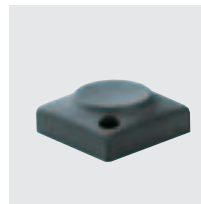

829 000 021*
828 000 021*

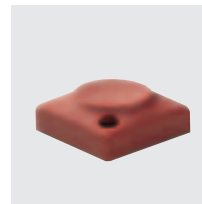

829 000 071*
828 000 071*



829 000 091*
828 000 091*

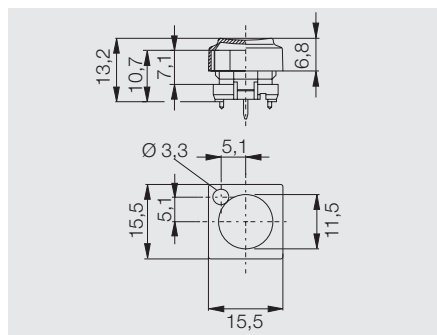

spacing 16 mm

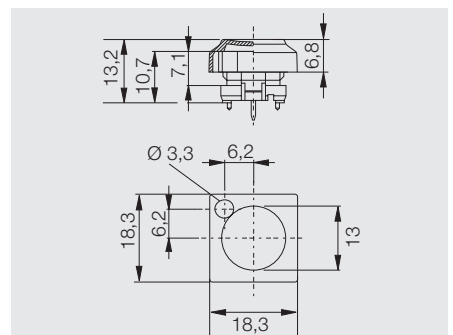

spacing 19 mm

SQUARE KEYCAPS

with white characters.

Please complete the reference numbers by the three figures below the respective character.

basic reference numbers for spacing 16 mm:
anthracite: 826 . . . 011
dark grey: 826 . . . 021

basic reference numbers for spacing 19 mm:
anthracite: 825 . . . 011
dark grey: 825 . . . 021

Other keycap colours and characters on request.



KEYCAPS WITH AND WITHOUT LED WINDOWS

FOR KEYMODULES OF SERIES 6425

ROUND KEYCAPS

with ergonomic surface area,
Ø 17 mm.

keycaps with characters and
other colours on request.



840 000 011*



840 000 021

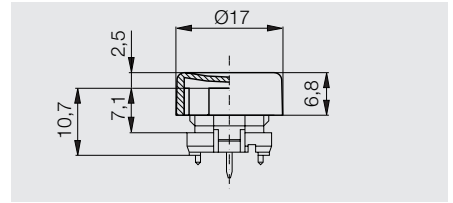

KEYCAPS

with oval surface area,
spacing 16 mm.



anthracite
dark grey
grey

827 020 011

827 020 021

827 020 031

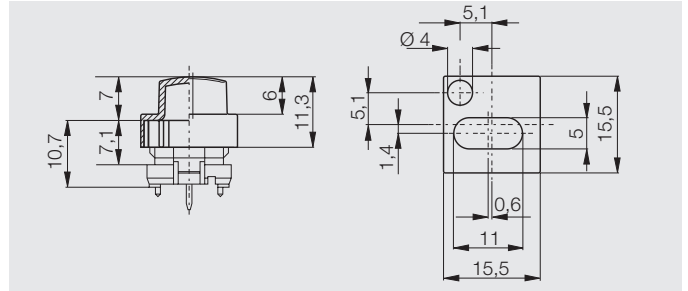

KEYCAPS

with round surface area,
spacing > 15 mm.



anthracite
dark grey
grey

827 100 011

827 100 021

827 100 031

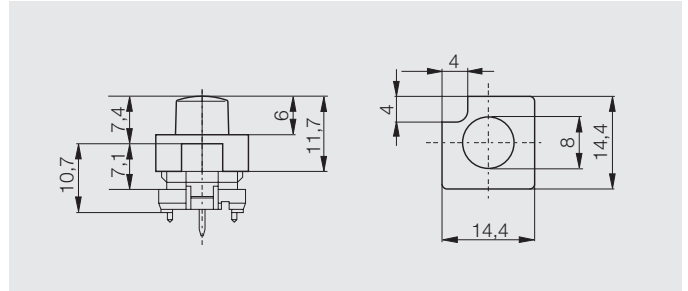

GUIDE MECHANISM FOR MULTIPLE KEYCAPS OF KEYMODULES SERIES 6425

GUIDE MECHANISM

The Marquardt guide mechanism for multiple keycaps guarantees optimum functioning even when actuated off-centre.

The guide mechanism can optionally be assembled with one or two LEDs.

6425.1101

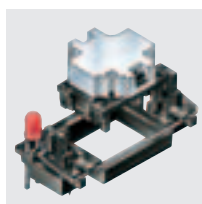

GUIDE MECHANISM FOR

two-fold keycaps, spacing 16 mm.

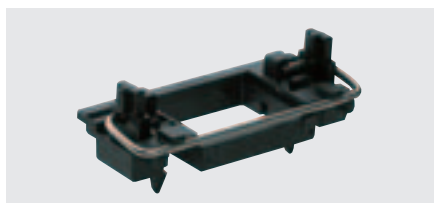

190 059 013

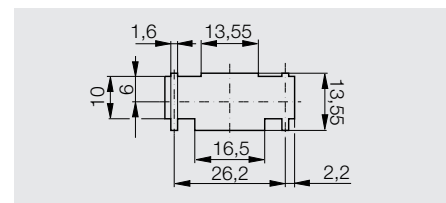

recommended cut-out

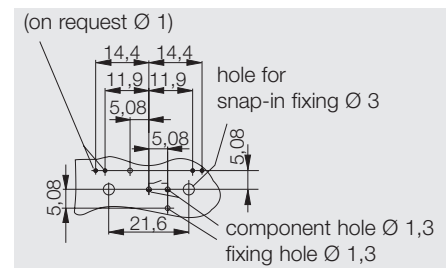

PC-board layout, component side

GUIDE MECHANISM FOR

three-fold keycaps, spacing 16 mm
two-fold keycaps, spacing 19 mm
three-fold keycaps, spacing 19 mm

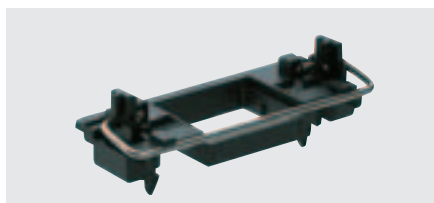

190 059 023

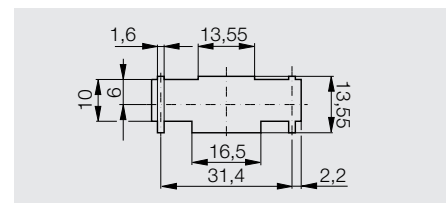

recommended cut-out

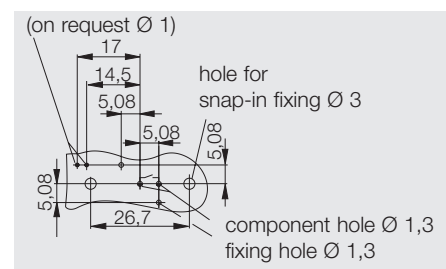

PC-board layout, component side

* Version on stock

MULTIPLE KEYCAPS WITH AND WITHOUT LED WINDOW FOR KEYMODULES OF SERIES 6425

TWO-FOLD KEYCAPS

spacing 16 mm, optionally with or without LED window

keycaps with characters on request

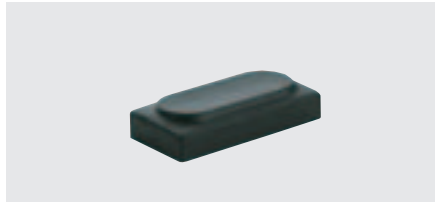

without LED window: 842 000 011 anthracite
842 000 021 dark grey
842 000 031 grey

with 1 LED window: 842 500 011 anthracite

with 2 LED windows: 842 800 011 anthracite

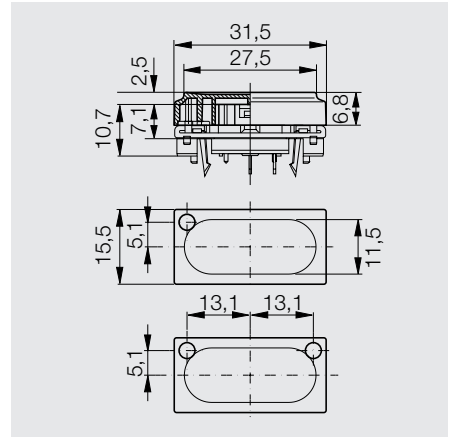

TWO-FOLD KEYCAPS

spacing 19 mm, optionally with or without LED window.

keycaps with characters on request.

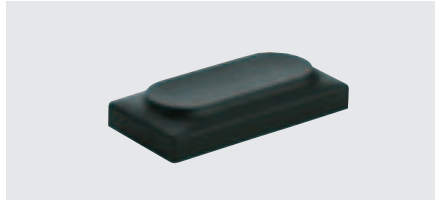

without LED window: 844 000 011 anthracite
844 000 021 dark grey
844 000 031 grey

with 1 LED window: 844 500 011 anthracite

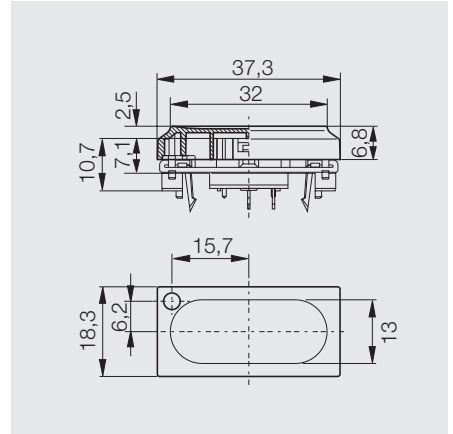

THREE-FOLD KEYCAPS

spacing 16 mm.

keycaps with characters on request

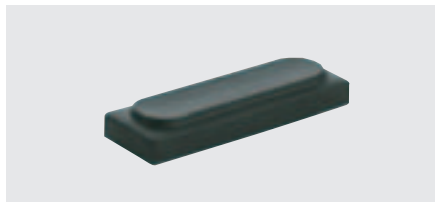

843 000 011 anthracite

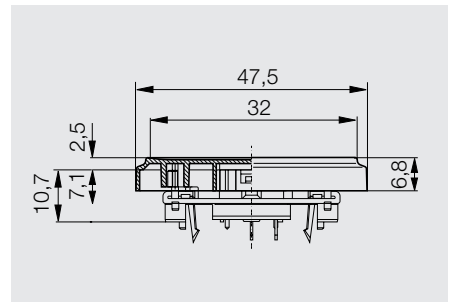

THREE-FOLD KEYCAPS

spacing 19 mm.

keycaps with characters on request

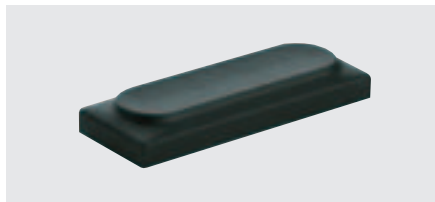

845 000 011 anthracite

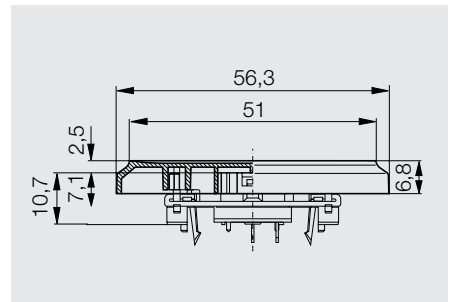

SERIES 6450 - KEYMODULES WITHOUT LED

PRODUCT ADVANTAGES

- ◆ Single pole normally open
- ◆ High life endurance
- ◆ Gold contacts guarantee secure switching function
- ◆ Short bounce time
- ◆ Comfortable actuation characteristic and low operating noise
- ◆ Low profile
- ◆ The keymodules are suitable for automatic soldering

TECHNICAL DATA

- ◆ Voltage max. 28 V
- ◆ Current max. 100 mA
- ◆ Life endurance >10⁶ cycles at 10 mA 12 V
- ◆ Contact resistance < 250 mΩ
- ◆ Insulation resistance (new state) > 100 MΩ
- ◆ Bounce time typical < 5 ms
- ◆ Ambient temperature -20 ... +70 °C
- ◆ Storage temperature -55 ... +75 °C
- ◆ Actuating force approx. 0,7 N
- ◆ Total travel max. 1.6 mm
- ◆ Housing made of thermoplastic material
- ◆ Contact material gold
- ◆ Terminals tinned

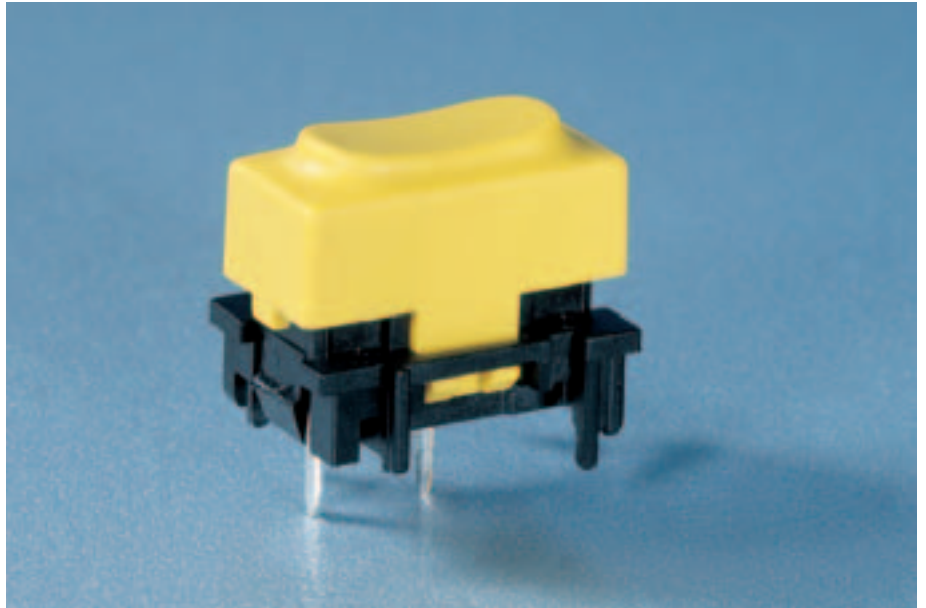

6450.0005*



6450.0003*



6450.0008

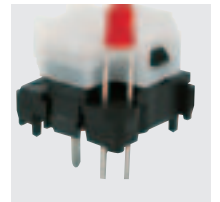

6450.0009

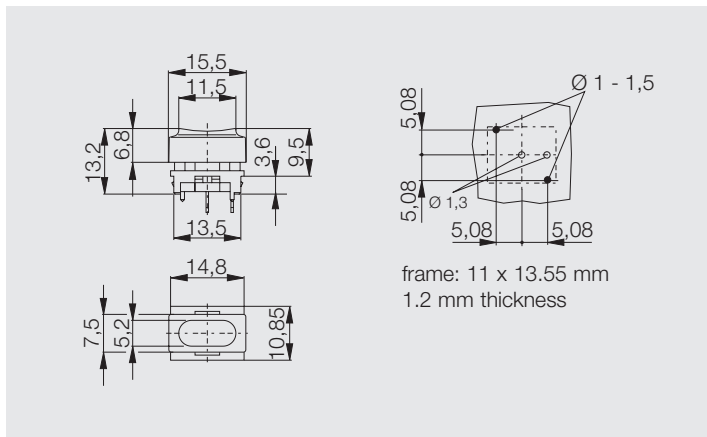

ON REQUEST

- ◆ Different colours
- ◆ Other signs and symbols



INDEX OF PART NUMBERS

1



TECHNICAL INFORMATION

Pages **1.1 - 1.5**

2



APPLIANCE SWITCHES

Pages **2.1- 2.48**

3



SNAP ACTION SWITCHES

Pages **3.1 - 3.33**

4

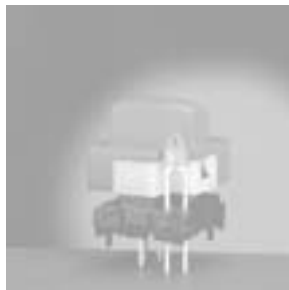

KEYMODULES

Pages **4.1 - 4.9**

5

INDEX OF PART NUMBERS

Seite **5.1 - 5.3**

INDEX OF PART NUMBERS

APPLIANCE SWITCHES

REF. NO.	PAGE	PIECES/PU*	REF. NO.	PAGE	PIECES/PU*	REF. NO.	PAGE	PIECES/PU*
1551.3102	2.26	150	1803.1102	2.10	500	1838.1402	2.16	250
1551.3202	2.26	150	1803.1202	2.11	500	1838.1502	2.16	250
1552.3102	2.26	150	1803.6102	2.10	500	1838.1509	2.16	250
1552.3602	2.26	150	1804.1102	2.10	250	1838.3402	2.16	250
1552.4602	2.26	150	1804.6102	2.10	250	1838.3502	2.16	250
1552.4606	2.26	150	1805.7104	2.8	250	1839.1402	2.16	150
1555.3102	2.26	150	1805.7109	2.8	250	1839.1407	2.16	150
1555.3104	2.26	150	1805.7110	2.8	250	1839.3402	2.16	150
1555.3108	2.26	150	1806.1102	2.8	250	1839.3502	2.16	150
			1807.1102	2.11	500			
1660.0201	2.36	100	1808.0102	2.10	500	1841.0101	2.28	250
1660.0202	2.36	100	1808.0111	2.10	500	1841.1101	2.28	250
1661.0101	2.36	100	1808.0302	2.10	500	1841.1201	2.28	250
1661.0201	2.36	100	1808.1102	2.10	500	1841.1301	2.28	250
1662.0101	2.36	100	1808.1103	2.10	500	1841.6101	2.28	250
1667.0102	2.37	200	1808.1302	2.10	500	1843.1101	2.28	250
			1808.2102	2.10	500	1843.1201	2.28	250
1670.5202	2.37	100	1808.2302	2.10	500			
1671.5201	2.37	100	1809.1102	2.10	250	1855.0102	2.21	400
			1809.1302	2.10	250	1855.0108	2.21	400
1681.1101	2.31	1.000				1855.1102	2.21	400
1681.3101	2.31	1.000	1811.1102	2.44	400	1855.1104	2.21	400
1681.3701	2.30	1.000	1812.1102	2.44	200	1855.1108	2.21	400
1681.4402	2.31	1.000	1813.1102	2.45	400			
1682.1101	2.31	1.000	1818.1102	2.45	400	1858.0103	2.23	300
1682.3101	2.31	1.000	1818.1302	2.45	400	1858.1102	2.23	300
			1819.1302	2.45	200	1858.1103	2.23	800
1683.1101	2.33	250				1858.1104	2.23	800
1684.1101	2.33	250	1821.0101	2.44	250	1858.4202	2.23	200
1686.1101	2.33	250	1821.1101	2.44	250	1858.4205	2.23	200
1687.1104	2.33	250	1822.0101	2.44	125			
			1822.1101	2.44	125	1901.1102	2.5	300
1800.1102	2.8	500	1823.0101	2.44	250	1901.1103	2.5	300
1800.1104	2.8	500	1823.1101	2.44	250	1911.1102	2.5	300
1800.1108	2.8	500	1824.1101	2.44	125	1921.1102	2.5	300
1801.0121	2.9	500	1828.0101	2.45	250			
1801.0136	2.9	500	1828.1101	2.45	250	1932.3112	2.19	100
1801.0202	2.11	500				1935.3112	2.19	100
1801.1102	2.9	500	1830.3112	2.14	200	1935.3113	2.19	100
1801.1119	2.9	500	1830.3118	2.14	200	1935.3114	2.19	100
1801.1121	2.9	500	1830.8112	2.14	200	1935.3118	2.19	100
1801.1139	2.9	500	1831.0114	2.14	200			
1801.1146	2.9	500	1831.3312	2.14	200	2410.0301	2.46	50
1801.1202	2.11	500	1831.3313	2.14	200	2410.0401	2.46	50
1801.1302	2.11	500	1831.8112	2.14	200			
1801.1403	2.9	500	1831.3933	2.14	200	4021.0101	2.39	250
1801.1908	2.9	500	1832.3311	2.15	100	4021.0512	2.39	250
1801.6102	2.9	500	1832.3312	2.15	100	4021.4420	2.39	300
1801.6115	2.9	500	1832.8112	2.15	100	4021.4620	2.39	300
1802.0130	2.9	250	1833.3302	2.15	200	4021.4723	2.39	200
1802.1102	2.9	250	1833.3305	2.15	200			
1802.1108	2.9	250	1834.3302	2.15	100	203 089 011	2.47	500
1802.1123	2.9	250	1834.3309	2.15	100	203 090 011	2.47	250
1802.1221	2.11	250	1834.3402	2.17	100	203 105 011	2.47	100
1802.3102	2.11	250	1835.3112	2.14	150	203 201 011	2.47	200
1802.5103	2.9	200	1835.3118	2.14	150	343 001 023	2.47	200
1802.6103	2.9	250	1837.3102	2.17	250			
1803.0202	2.11	500	1837.8102	2.17	150			

INDEX OF PART NUMBERS

SNAP ACTION SWITCHES

KEYMODULES

REF. NR.	PAGE	PIECES/PU*	REF. NO.	PAGE	PIECES/PU*	REF. NO.	PAGE	PIECES/PU*
1004.1001	3.19	400	1050.7702	3.12	200	6425.0101	4.2	200
1004.1002	3.19	400	1055.0351	3.8	1500	6425.1101	4.2	200
1005.0401	3.19	500	1056.0351	3.8	2000	6425.3111	4.3	200
1005.0404	3.19	500	1056.3060	3.8	2000	6425.4111	4.3	200
1005.1001	3.19	400	1056.3351	3.8	1500	6425.6111	4.3	200
1005.1004	3.19	400	1058.0351	3.9	500			
1005.1105	3.19	400				6450.0003	4.9	200
1005.1201	3.19	400	1080.0103	3.16	500	6450.0005	4.9	200
1005.1204	3.19	400	1080.0403	3.16	400			
1006.0701	3.20	400	1085.0403	3.16	400	825 000 011	4.4	100
1006.1011	3.20	200				825 000 021	4.4	100
1006.1201	3.20	400	1117.0101	3.31	500	825 000 071	4.4	100
1006.1301	3.20	250	1117.0201	3.31	500	825 000 091	4.4	100
1006.1401	3.20	200						
1006.1511	3.20	200	190 072 013	3.13	250	826 000 011	4.4	100
1006.1801	3.21	200	190 074 013	3.13	250	826 000 021	4.4	100
			190 075 013	3.13	250	826 000 071	4.4	100
						826 000 091	4.4	100
1010.0101	3.26	250						
1010.0304	3.25	250	191 071 011	3.13	250			
1010.2003	3.25	250	191 071 021	3.13	250	828 000 011	4.4	100
1010.7401	3.25	250	191 071 041	3.13	250	828 000 021	4.4	100
1010.9705	3.26	200	191 071 051	3.13	250	828 000 071	4.4	100
1010.9752	3.26	200	191 071 101	3.13	250	828 000 091	4.4	100
1010.9802	3.26	250	191 078 013	3.13	250			
1010.9852	3.26	200	191 078 023	3.13	250	829 000 011	4.4	100
			191 079 013	3.15	250	829 000 021	4.4	100
1019.0101	3.23	250	191 079 023	3.15	250	829 000 071	4.4	100
1019.0201	3.23	250	191 080 091	3.15	250	829 000 091	4.4	100
1019.2101	3.23	200	191 080 101	3.15	250			
1019.3101	3.23	200	191 080 451	3.15	250	840 000 011	4.6	100
1019.5101	3.23	400	191 080 471	3.15	250			
1019.5401	3.23	400						
1019.5501	3.23	400	231 009 011	3.21	250			
1019.5601	3.23	400	231 009 021	3.21	250			
			231 010 011	3.21	250			
1022.4501	3.29	200	231 010 021	3.21	250			
1040.0114	3.32	250						
1050.0102	3.11	250						
1050.0103	3.11	250						
1050.0122	3.11	250						
1050.0202	3.12	250						
1050.1102	3.11	250						
1050.1151	3.11	250						
1050.1202	3.12	250						
1050.2102	3.11	250						
1050.2122	3.11	250						
1050.2151	3.11	250						
1050.2202	3.12	250						
1050.5202	3.12	200						
1050.5251	3.12	200						
1050.5502	3.12	200						
1050.5702	3.12	200						
1050.6702	3.12	200						
1050.7202	3.12	200						

* Minimum packaging units resp. minimum order quantity.



Marquardt GmbH

Schloss-Str. 16 · 78604 Rietheim-Weilheim · Germany · Telephone +49 (7424) 99-0 · Telefax +49 (7424) 99-2399
www.marquardt.de · marquardt@marquardt.de

Marquardt GmbH · Branch Böttingen

Spaichinger Weg 1 · 78583 Böttingen · Germany · Telephone +49 (74 29) 94 03-0 · Telefax +49(74 29) 94 03-260
www.marquardt.de · marquardt@marquardt.de